

# User Manual

---

OH75A

---

The colour and the appearance may differ depending on the product, and the specifications are subject to change without prior notice to improve the performance.

An administration fee may be charged in the following situations:

- (a) An engineer is called out at your request, but it is found that the product has no defect (i.e., where the user manual has not been read).
- (b) You bring the unit to a repair centre, but it is found that the product has no defect (i.e., where the user manual has not been read).

You will be informed of the administration fee amount before a technician visits.

---

# Table of contents

## Before Using the Product

---

Safety Precautions	6
Safety symbols	6
Electricity and Safety	7
Installation	8
Operation	9
Cleaning	11
Storage	11

## Preparations

---

Checking the Components	12
Components	12

---

Parts	13
Front	13
Reverse Side	14
Remote Control	15

---

Before Installing the Product (Installation Guide)	17
Switching between portrait and landscape	17
Ventilation	17

---

Wall Mount Specifications	18
---------------------------	----

---

Remote Control (RS232C)	19
Cable Connection	19
Connection	22
Control Codes	23

## Connecting and Using a Source Device

---

Before Connecting	31
Pre-connection Checkpoints	31
Before connecting cables	32
Power cable connection guide	33

---

Connecting to a PC	34
Connection Using an HDMI Cable	34
Connection Using an HDMI-DVI Cable	34
Connection Using an DP Cable	35

---

Connecting to a Video Device	36
Connection Using an HDMI-DVI Cable	36
Connection Using an HDMI Cable	36

---

Connecting to an Audio System	37
-------------------------------	----

---

Connecting the LAN Cable	37
--------------------------	----

---

Changing the Input source	38
Source	38
Web Browser	39
Screen Mirroring	41
Samsung Workspace	41

## Using MDC

---

MDC Programme	
Installation/Uninstallation	42
Installation	42
Uninstallation	42

---

Connecting to MDC	43
Using MDC via RS-232C (serial data communications standards)	43
Using MDC via Ethernet	44

## Player feature

---

Player	45
Viewing content	45
When content is running	46
Available menu	46
File Formats Compatible with Player	47

---

Schedule	51
----------	----

---

Clone Product	52
---------------	----

---

ID Settings	53
Device ID	53
PC Connection Cable	53

---

# Table of contents

---

Video Wall	54
Video Wall	54
Horizontal x Vertical	54
Screen Position	55
Format	55
<b>Network Status</b>	<b>55</b>
<b>On/Off Timer</b>	<b>56</b>
On Timer	56
Off Timer	57
Holiday Management	57
<b>Ticker</b>	<b>57</b>
<b>URL Launcher</b>	<b>58</b>
<b>URL Launcher Settings</b>	<b>58</b>

## Screen Adjustment

---

Backlight / Brightness / Contrast / Sharpness	59
Colour Temperature	60
Advanced Settings	61

---

Picture Enhancer	61
Colour	61
Tint (G/R)	61
White Balance	62
Gamma	62
Contrast Enhancer	62
Black Tone	62
Flesh Tone	63
RGB Only Mode	63
Colour Space Settings	63
Input Signal Plus	63
Motion Lighting	63
<b>Picture Options</b>	<b>64</b>
Colour Tone	64
Digital Clean View	64
HDMI Black Level	64
Film Mode	64
Auto Motion Plus Settings	64
Local Dimming	65
Dynamic Peaking	65
<b>Apply Picture Settings</b>	<b>66</b>
<b>Picture Size Settings</b>	<b>67</b>
Picture Size	67
Fit to screen	67
Zoom and Position	67
<b>Reset Picture</b>	<b>68</b>

## OnScreen Display

---

<b>Display Orientation</b>	<b>69</b>
Onscreen Menu Orientation	69
Source Content Orientation	69
Aspect Ratio	69
<b>Screen Protection</b>	<b>70</b>
Auto Protection Time	70
Screen Burn Protection	70
<b>Message Display</b>	<b>71</b>
Source Info	71
No Signal Message	71
MDC Message	71
Download Status Message	71
<b>Language</b>	<b>72</b>
<b>Reset OnScreen Display</b>	<b>72</b>

---

# Table of contents

## Network

---

Network Status	73
Open Network Settings	73
Network Settings (Wired)	74
Server Network Settings	77
Connect to server	77
MagicInfo Mode	77
Server Access	77
FTP Mode	77
Proxy server	77
Device Name	77

## System

---

Accessibility	78
Voice Guide Settings	78
High Contrast	79
Enlarge	79

---

Start Setup	79
Time	80
Clock Set	80
NTP Settings	80
DST	80
Power On Delay	80
Auto Source Switching	81
Auto Source Switching	81
Primary Source Recovery	81
Primary Source	81
Secondary Source	81
Default Input	81
Power Control	82
Auto Power On	82
Max. Power Saving	82
Standby Control	82
Remote Configuration	83
Power Button	83
Eco Solution	84
Brightness Limit	84
Energy Saving Mode	84
Eco Sensor	84
Screen Lamp Schedule	85
No Signal Power Off	85
Auto Power Off	85

---

Fan Settings	86
Fan Control	86
Fan Speed Setting	86
Outdoor Mode	86
Play via	87
Change PIN	87
Security	88
Safety Lock On	88
Screen Monitoring Lock	88
USB Auto Play Lock	89
Remote Management	89
Secured Protocol	89
Server Security Status	89
Network Lock	89
USB Lock	89
General	90
Smart Security	90
Anynet+ (HDMI-CEC)	90
HDMI Hot Plug	92
Custom Logo	92
Game Mode	93
Empty Storage	93
Reset System	93

---

# Table of contents

## Support

---

Software Update	94
Update Now	94
Contact Samsung	94
Reset All	94

## Troubleshooting Guide

---

Requirements Before Contacting Samsung Customer Service Centre	95
Testing the Product	95
Checking the Resolution and Frequency	95
Check the followings.	96
Q & A	101

## Specifications

---

General	103
Preset Timing Modes	105

## Appendix

---

Responsibility for the Pay Service (Cost to Customers)	108
Not a product defect	108
A Product damage caused by customer's fault	108
Others	108
Prevention of Afterimage Burn-in	109
What is afterimage burn-in?	109
Recommended prevention practices	109
Licence	110
Terminology	111





# Chapter 01







## Before Using the Product

### Safety Precautions

The following safety instructions are to ensure your personal safety and prevent property damage. Please read the following to ensure the proper use of the product.

#### Safety symbols

Symbol	Name	Meaning
	Warning	A serious or fatal injury may result if instructions are not followed.
	Caution	Personal injury or damage to properties may result if instructions are not followed.
	Prohibition	Do NOT attempt.
	Instruction	Follow directions.

CAUTION			
RISK OF ELECTRIC SHOCK. DO NOT OPEN.			
CAUTION: TO REDUCE THE RISK OF ELECTRIC SHOCK, DO NOT REMOVE COVER (OR BACK). THERE ARE NO USER SERVICEABLE PARTS INSIDE. REFER ALL SERVICING TO QUALIFIED PERSONNEL.			
	This symbol indicates that high voltage is present inside. It is dangerous to make any kind of contact with any internal part of this product.		AC voltage: Rated voltage marked with this symbol is AC voltage.
	This symbol indicates that this product has included important literature concerning operation and maintenance.		DC voltage: Rated voltage marked with this symbol is DC voltage.
	Class II product: This symbol indicates that a safety connection to electrical earth (ground) is not required. If this symbol is not present on a product with a mains lead, the product MUST have a reliable connection to protective earth (ground).		Caution. Consult instructions for use: This symbol instructs the user to consult the user manual for further safety related information.

---

## Electricity and Safety

### Warning

Do not use a damaged power cord or plug, or a loose power socket.

- An electric shock or fire may result.

Do not use multiple products with a single power socket.

- Overheated power sockets may cause a fire.

Do not touch the power plug with wet hands. Otherwise, an electric shock may result.

Insert the power plug all the way in so it is not loose.

- An unsecure connection may cause a fire.

Connect the power plug to a grounded power socket (type 1 insulated devices only).

- An electric shock or injury may result.

Do not bend or pull the power cord with force. Be careful not to leave the power cord under a heavy object.

- Damage to the cord may result in a fire or electric shock.

Do not place the power cord or product near heat sources.

- A fire or electric shock may result.

Clean any dust around the pins of the power plug or the power socket with a dry cloth.

- A fire may result.

### Caution

Do not disconnect the power cord while the product is being used.

- The product may become damaged by an electric shock.

Only use the power cord provided with your product by Samsung. Do not use the power cord with other products.

- A fire or electric shock may result.

Keep the power socket where the power cord is connected unobstructed.

- The power cord must be disconnected to cut off power to the product when an issue occurs.
- Note that the product is not completely powered down by using only the power button on the remote.

Hold the plug when disconnecting the power cord from the power socket.

- An electric shock or fire may result.

---

## Installation

### Warning

DO NOT PLACE CANDLES, INSECT REPELLANTS OR CIGARETTES ON TOP OF THE PRODUCT. DO NOT INSTALL THE PRODUCT NEAR HEAT SOURCES.

- A fire may result.

Have a technician install the wall-mount hanger.

- Installation by an unqualified person can result in an injury.
- Only use approved cabinets.

Do not install the product in poorly ventilated spaces such as a bookcase or closet.

- An increased internal temperature may cause a fire.

When installing the product, keep it at a distance from the wall so that it is well ventilated.

— Refer to the Outdoor Installation Guide. (<http://displaysolutions.samsung.com>)

- An increased internal temperature may cause a fire.

Keep the plastic packaging out of the reach of children.

- Children may suffocate.

Do not install the product on an unstable or vibrating surface (insecure shelf, sloped surface, etc.)

- The product may fall and become damaged and/or cause an injury.
- Using the product in an area with excess vibration may damage the product or cause a fire.

Do not install the product within the reach of young children.

- The product may fall and injure children.
- As the front is heavy, install the product on a flat and stable surface.

Edible oil, such as soybean oil, can damage or deform the product. Do not install the product in a kitchen or near a kitchen counter.

Precautions during installation and storage

- After opening the cover, install the product within 1 hour under humidity of 60% or below. ([P. 32](#))
- Keep the predefined humidity while opening the cover or assembling the housing (e.g. connection of external device, F/W update).
- During operation and storage of the product, be sure to attach the cover.

### Caution

Do not drop the product while moving.

- Product failure or personal injury may result.

Do not set down the product on its front.

- The screen may become damaged.

When installing the product on a cabinet or shelf, make sure that the bottom edge of the front of the product is not protruding.

- The product may fall and become damaged and/or cause an injury.
- Install the product only on cabinets or shelves of the right size.

Set down the product gently.

- Product failure or personal injury may result.

If the product is installed in an unusual location, the surrounding environment may cause a serious quality problem. Therefore, be sure to contact Samsung Customer Service Centre before installation.

- Places where many fine dusts are generated, places where chemicals are used, places with too high or low temperatures, places with a lot of moisture or water, transportation equipment such as vehicles, airports and stations used continuously for a long time, and more.



---

## Operation

### Warning

There is a high voltage inside the product. Never disassemble, repair or modify the product yourself.

- A fire or electric shock may result.
- Contact Samsung Customer Service Centre for repairs.

If the product generates abnormal sounds, a burning smell or smoke, disconnect the power cord immediately and contact Samsung Customer Service Centre.

- An electric shock or fire may result.

Do not let children hang from the product or climb on top of it.

- Children may become injured or seriously harmed.

Do not leave heavy objects or items that children like (toys, sweets, etc.) on top of the product.

- The product or heavy objects may fall as children try to reach for the toys or sweets resulting in a serious injury.

Do not drop objects on the product or apply impact.

- A fire or electric shock may result.

Do not move the product by pulling the power cord or any cable.

- Product failure, an electric shock or fire may result from a damaged cable.

If a gas leakage is found, do not touch the product or power plug. Also, ventilate the area immediately.

- Sparks can cause an explosion or fire.

Do not lift or move the product by pulling the power cord or any cable.

- Product failure, an electric shock or fire may result from a damaged cable.

Do not use or keep combustible spray or an inflammable substance near the product.

- An explosion or fire may result.

Ensure the vents are not blocked by tablecloths or curtains.

- An increased internal temperature may cause a fire.

Do not insert metallic objects (chopsticks, coins, hairpins, etc) or objects that burn easily (paper, matches, etc) into the product (via the vent or input/output ports, etc).

- Be sure to power off the product and disconnect the power cord when water or other foreign substances have entered the product. Then contact Samsung Customer Service Centre.
- Product failure, an electric shock or fire may result.

Do not block the vent on the product. The product may not function properly due to potential overheating.

Do not attempt to insert your fingers or objects into the vents.

- Product failure or personal injury may result.

---

## Caution

Leaving the screen fixed on a stationary image for an extended period of time may cause afterimage burn-in or defective pixels.

- Activate power-saving mode or a moving-picture screen saver if you will not be using the product for an extended period of time.

Disconnect the power cord from the power socket if you do not plan on using the product for an extended period of time (vacation, etc).

- Dust accumulation combined with heat can cause a fire, electric shock or electric leakage.

Use the product at the recommended resolution and frequency.

- Your eyesight may deteriorate.

Do not hold the product upside-down or move it by holding the stand.

- The product may fall and become damaged or cause an injury.

Looking at the screen too close for an extended period of time can deteriorate your eyesight.

Rest your eyes for more than 5 minutes for every 1 hour of product use.

- Eye fatigue will be relieved.

Do not touch the screen when the product has been turned on for an extended period of time as it will become hot.

Store small accessories out of the reach of children.

Exercise caution when adjusting the product angle or stand height.

- Your hand or finger may get stuck and injured.
- Tilting the product at an excessive angle may cause the product to fall and an injury may result.

Do not place heavy objects on the product.

- Product failure or personal injury may result.

When using headphones or earphones, do not turn the volume too high.

- Having the sound too loud may damage your hearing.

Be careful that children do not place the battery in their mouths when removed from the remote control. Place the battery in a location that children or infants cannot reach.

- If children have had the battery in their mouths, consult your doctor immediately.

When replacing the battery, insert it with the right polarity (+, -).

- Otherwise, the battery may become damaged or it may cause fire, personal injury or damage due to leakage of the internal liquid.

Use only the specified standardised batteries, and do not use a new battery and a used battery at the same time.

- Otherwise, the batteries may be damaged or cause fire, personal injury or damage due to a leakage of the internal liquid.

The batteries (and rechargeable batteries) are not ordinary refuse and must be returned for recycling purposes. The customer is responsible for returning the used or rechargeable batteries for recycling.

- The customer can return used or rechargeable batteries to a nearby public recycling centre or to a store selling the same type of the battery or rechargeable battery.

---

## Cleaning

- Exercise care when cleaning as the panel and exterior of advanced LCDs are easily scratched.
- Take the following steps when cleaning.

**1** Power off the product and computer.

**2** Disconnect the power cord from the product.

- Hold the power cable by the plug and do not touch the cable with wet hands. Otherwise, an electric shock may result.

**3** Use water and a dry cloth to clean the protection glass.

- Wipe with a clean wet cloth.

- To remove tough stains, wipe using a cloth with a small amount of ethanol based cleaner.

Use a brush to remove any debris from the inlet and outlet opening.

- To remove tough stains, wipe using a cloth with a small amount of ethanol based cleaner.

- If washing with water, keep the pressure below 0.5 bar.

**4** Connect the power cord to the product when cleaning is finished.

**5** Power on the product and computer.

## Storage

Due to the characteristics of high-glossy products, using a UV humidifier nearby may create white-coloured stains on the product.

- Contact Customer Service Centre if the inside of the product needs cleaning (service fee will be charged).

# Chapter 02

## Preparations

### Checking the Components

#### Components

- Contact the vendor where you purchased the product if any components are missing.
- The appearance of the components may differ from the images shown.
- A stand is not provided with the product. To install a stand, you can purchase one separately.



Quick setup guide



Warranty card  
(Not available in some locations)



Regulatory guide



Remote Control

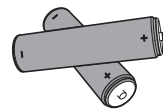

Batteries  
(Not available in some locations)

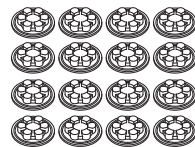

Cover-Cap (16 EA)

---

## Parts

### Front

— The colour and shape of parts may differ from what is shown. Specifications are subject to change without notice to improve quality.

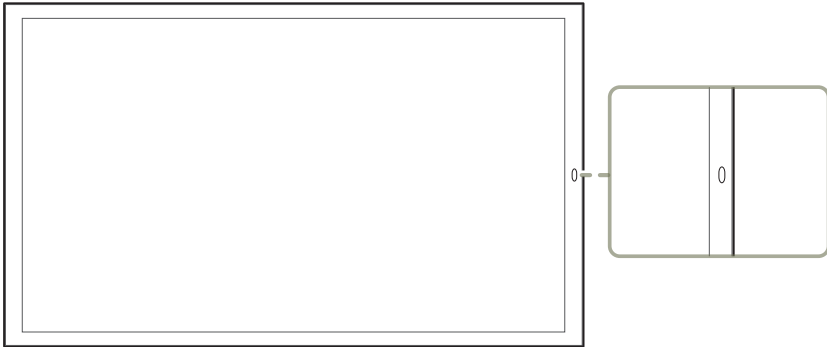

Port	Description
Remote sensor	<p>Press a button on the remote control pointing at the sensor on the front of the product to perform the corresponding function.</p> <p>— Using other display devices in the same space as the remote control of this product can cause the other display devices to be inadvertently controlled.</p>

## Reverse Side

— The colour and shape of parts may differ from what is shown.  
Specifications are subject to change without notice to improve quality.

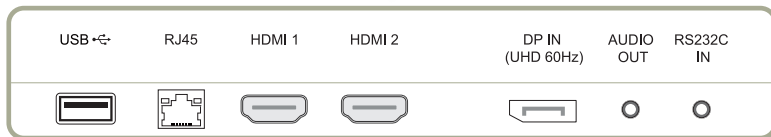
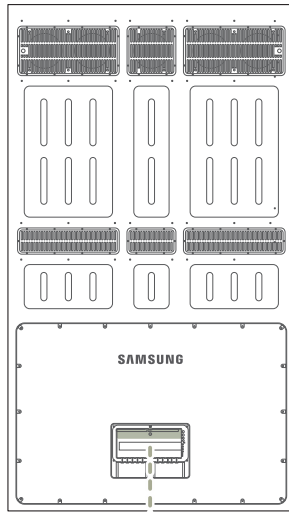

## Port

## Description

USB 	Connect to a USB memory device.
RJ45	Connects to MDC using a LAN cable. (10/100 Mbps) — Use Cat7(*STP Type) cable for the connection. *Shielded Twisted Pair
HDMI1, HDMI 2	Connects to a source device using a HDMI cable or HDMI-DVI cable.
DP IN (UHD 60Hz)	Connects to a PC using a DP cable. — Obtain sharp picture quality when viewing UHD content at 60Hz.
AUDIO OUT	Outputs sound to an audio device via an audio cable.
RS232C IN	Connects to MDC using an RS232C adapter.

# Remote Control

- Using other display devices in the same space as the remote control of this product can cause the other display devices to be inadvertently controlled.
- A button without a description in the image below is not supported on the product.

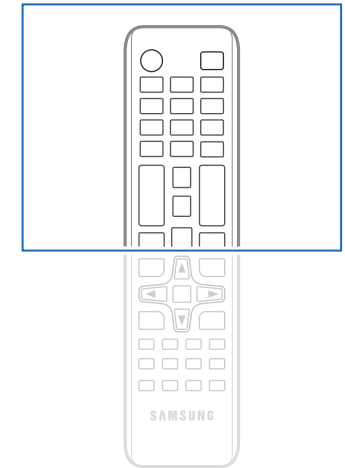
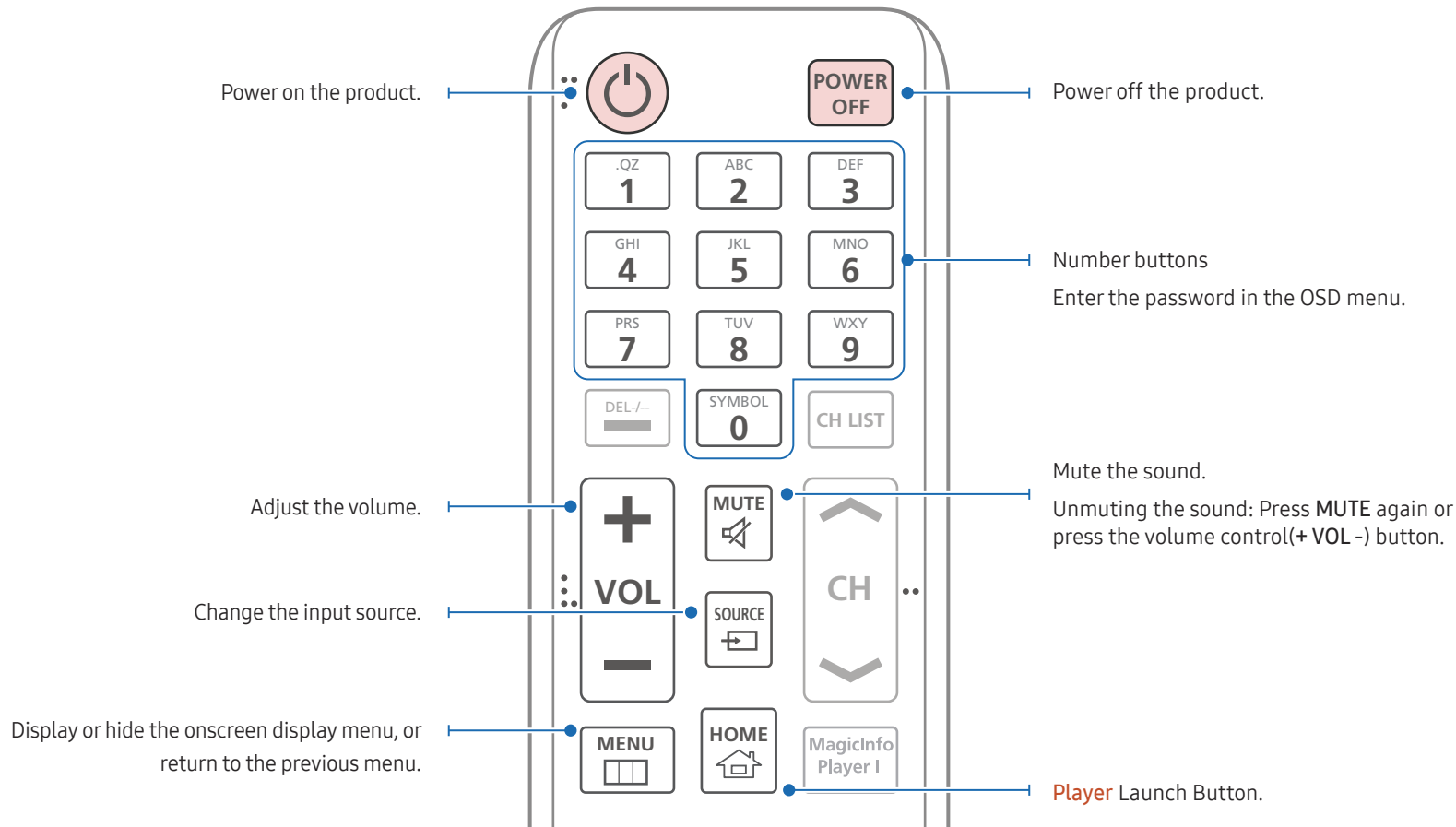

– Remote control button functions may differ for different products.

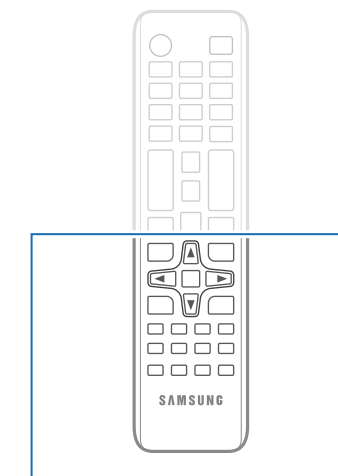
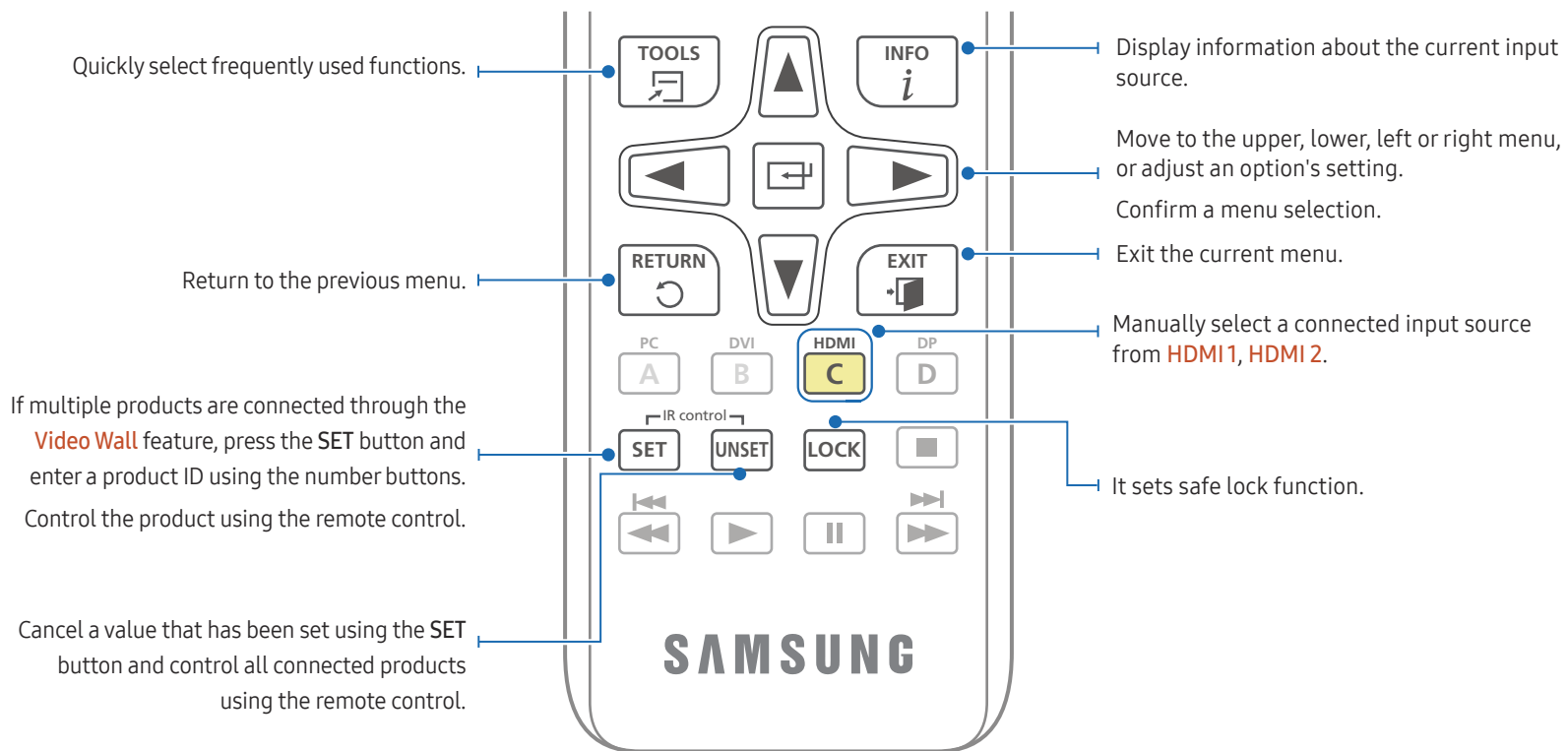

- Remote control button functions may differ for different products.
- Remove batteries when the remote control is not to be used for an extended period of time.

### To place batteries in the remote control

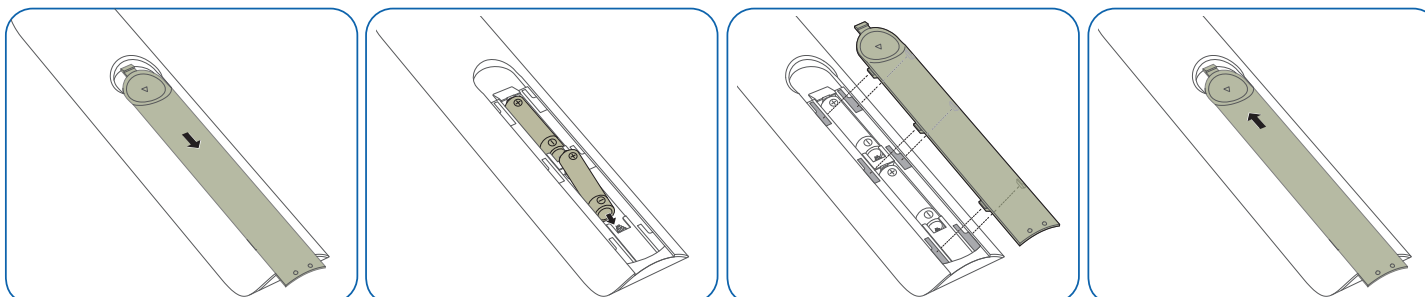



## Before Installing the Product (Installation Guide)

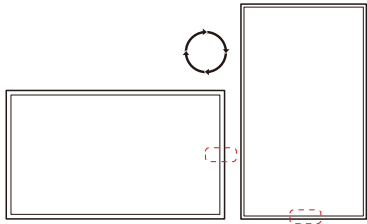

— Do not use this model installed on a ceiling, floor, or table.

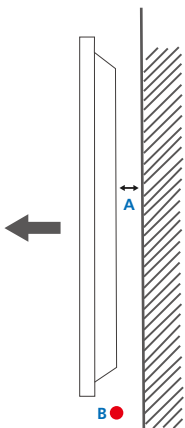
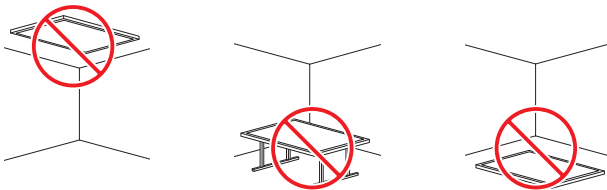

Figure 1.1 Side view

To prevent injury, this apparatus must be securely attached to the floor/wall in accordance with the installation instructions.

- Ensure that an authorised installation company installs the wall mount.
- Otherwise, it may fall and cause personal injury.
- Make sure to install the specified wall mount.

If the product temperature increases due to high outside temperature or the environment in which the product is installed, the luminance decreases for product overheating mitigation and accident prevention.

## Switching between portrait and landscape

— Contact Samsung Customer Service Centre for further details.

- To use the product vertically (portrait), turn it clockwise so that the IR LED is pointing down.

## Ventilation

### Installation on a Perpendicular Wall

A Minimum 60 mm

- Exposure to direct sunlight: 200 mm or more
- Atmospheric temperatures under 35 °C without direct sunlight: 60 mm or more

B Ambient temperature: Under 50 °C

- When installing the product on a perpendicular wall, allow at least 60 mm of space between the product and wall surface for ventilation and ensure that the ambient temperature is kept below 50 °C.

— Refer to the Outdoor Installation Guide. (<http://displaysolutions.samsung.com>)

# Wall Mount Specifications

- Install the wall mount on a solid wall that is perpendicular to the floor. If you install the product on a slanted wall, it may fall and result in severe personal injury. Before attaching the wall mount to surfaces other than plaster board, please contact your nearest Service Centre for additional information.
- Do not mount the product at more than a 15 degree tilt.
- Do not fasten the screws too firmly. This may damage the product or cause the product to fall, leading to personal injury. Samsung is not liable for these kinds of accidents.
- Do not keep the product turned on during the installation of the wall mount. It may result in personal injury due to electric shock.
- Do not use the guide holes for wall mounting.

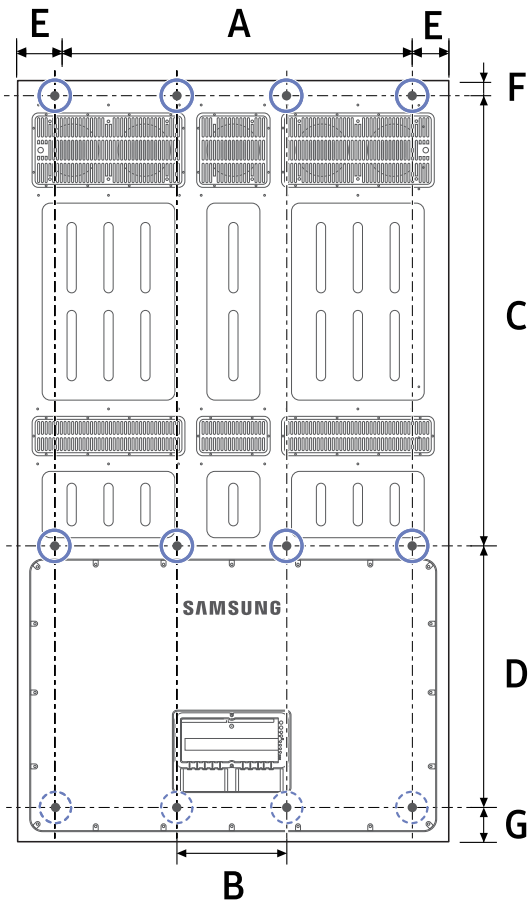

Unit: mm

Screw hole specs (A * B) in millimetres	870 x 260
Screw hole specs (C * D) in millimetres	1118.4 x 538.2
E	91.7
F	40.8
G	77.4
BOLT SIZE	M8

- : Wall Mount Holes (8 Points)
- ⊙: Guide Holes (4 Points) (Do not use the guide holes for wall mounting)

# Remote Control (RS232C)

## Cable Connection

### RS232C Cable

Interface	RS232C (9 pins)
Pin	TxD (No.2), RxD (No.3), GND (No.5)
Bit rate	9600 bps
Data bits	8 bit
Parity	None
Stop bit	1 bit
Flow control	None
Maximum length	15 m (only shielded type)

- Pin assignment

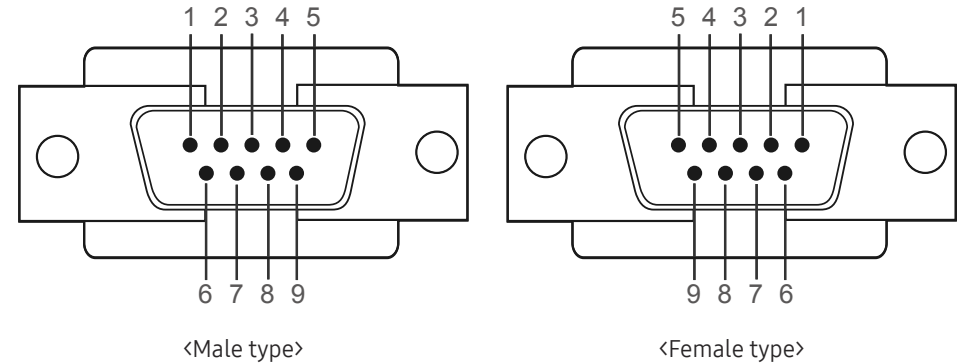

Pin	Signal
1	Detect data carrier
2	Received data
3	Transmitted data
4	Prepare data terminal
5	Signal ground
6	Prepare data set
7	Send request
8	Clear to send
9	Ring indicator

- RS232C cable  
Connector: 9-Pin D-Sub to Stereo Cable

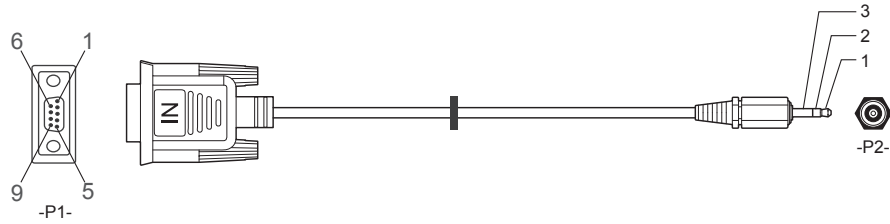

		-P1-		-P2-		-P2-
Male type	Rx	2	-----	1	Tx	STEREO
	Tx	3	-----	2	Rx	PLUG
	Gnd	5	-----	3	Gnd	(3.5ø)

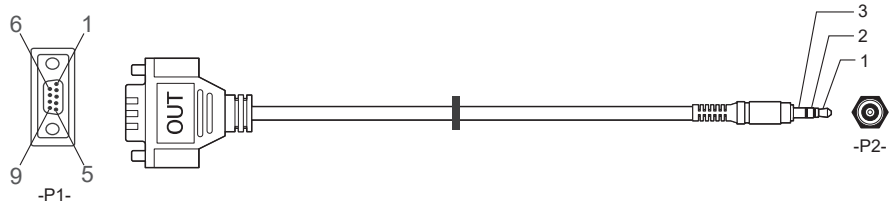

		-P1-		-P2-		-P2-
Female type	Rx	3	-----	1	Tx	STEREO
	Tx	2	-----	2	Rx	PLUG
	Gnd	5	-----	3	Gnd	(3.5ø)

## LAN Cable

- Pin assignment

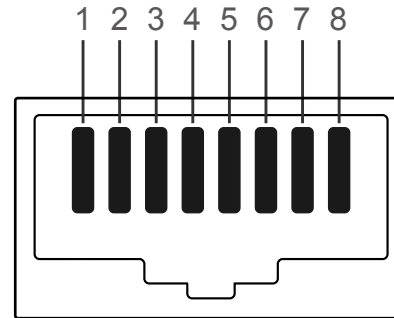

Pin No	Standard Colour	Signal
1	White and orange	TX+
2	Orange	TX-
3	White and green	RX+
4	Blue	NC
5	White and blue	NC
6	Green	RX-
7	White and brown	NC
8	Brown	NC

— This function may differ depending on the model.

- Connector : RJ45

### Direct LAN cable (PC to HUB)

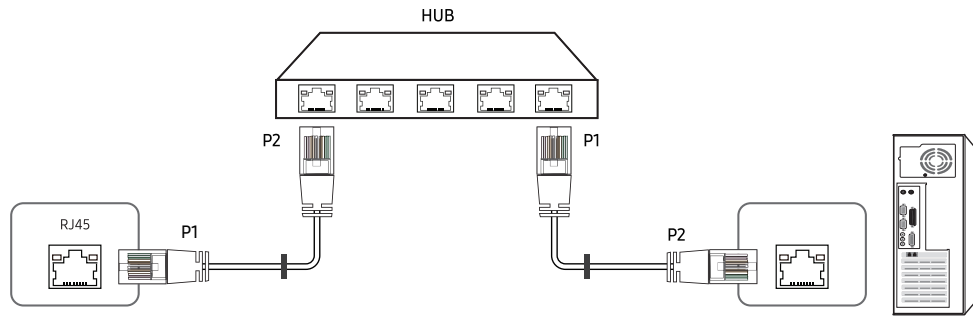

Signal	P1		P2	Signal
TX+	1	↔	1	TX+
TX-	2	↔	2	TX-
RX+	3	↔	3	RX+
RX-	6	↔	6	RX-

### Cross LAN cable (PC to PC)

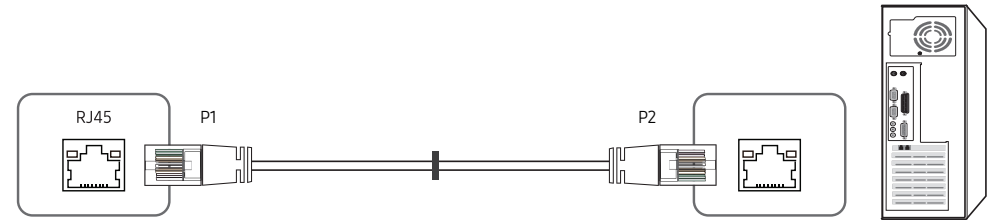

Signal	P1		P2	Signal
TX+	1	↔	3	RX+
TX-	2	↔	6	RX-
RX+	3	↔	1	TX+
RX-	6	↔	2	TX-

---

## Connection

- Connection 1

— Ensure that you connect the RS232C(IN) adapter to the RS232C IN port on the product.

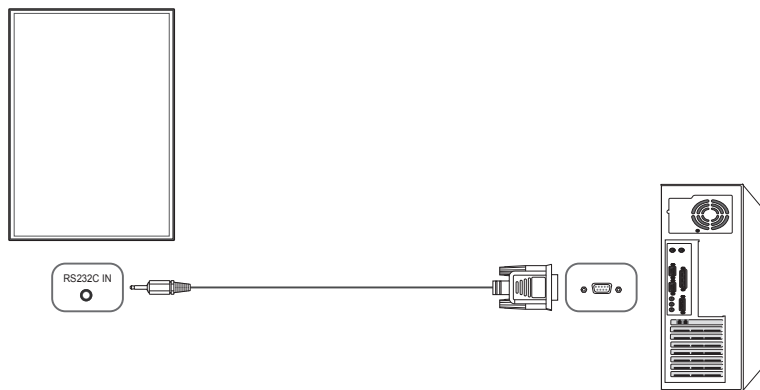

## Control Codes

### Viewing control state (Get control command)

Header	Command	ID	Data length	Checksum
0xAA	Command type		0	

### Controlling (Set control command)

Header	Command	ID	Data length	Data	Checksum
0xAA	Command type		1	Value	

### Command

No.	Command type	Command	Value range
1	Power control	0x11	0~1
2	Volume control	0x12	0~100
3	Input source control	0x14	-
4	Screen mode control	0x18	-
5	Screen size control	0x19	0~255
6	Video wall mode control	0x5C	0~1
7	Safety Lock	0x5D	0~1
8	Video Wall On	0x84	0~1

No.	Command type	Command	Value range
9	Video Wall User Control	0x89	-

- All communications take place in hexadecimals. The checksum is calculated by adding up all values except the header. If a checksum adds up to be more than 2 digits as shown below (11+FF+01+01=112), the first digit is removed.

E.g. Power On & ID=0

Header	Command	ID	Data length	Data 1	Checksum
0xAA	0x11		1	"Power"	
Header	Command	ID	Data length	Data 1	Checksum
0xAA	0x11		1	1	12

- To control all devices connected by a serial cable simultaneously irrespective of IDs, set the ID as "0xFE" and transmit commands. Commands will be executed by each device but ACK will not respond.

## Power control

- Function  
A product can be powered on and off using a PC.
- Viewing power state (Get Power ON / OFF Status)

Header	Command	ID	Data length	Checksum
0xAA	0x11		0	

- Setting power ON/Off (Set Power ON / OFF)

Header	Command	ID	Data length	Data	Checksum
0xAA	0x11		1	"Power"	

"Power": Power code to be set on a product.

1: Power ON

0: Power OFF

- Ack

Header	Command	ID	Data length	Ack/Nak	r-CMD	Val1	Checksum
0xAA	0xFF		3	'A'	0x11	"Power"	

"Power": Power code to be set on a product.

- Nak

Header	Command	ID	Data length	Ack/Nak	r-CMD	Val1	Checksum
0xAA	0xFF		3	'N'	0x11	"ERR"	

"ERR" : A code showing what error has occurred.

## Volume control

- Function  
The volume of a product can be adjusted using a PC.
- Viewing volume state (Get Volume Status)

Header	Command	ID	Data length	Checksum
0xAA	0x12		0	

- Setting the volume (Set Volume)

Header	Command	ID	Data length	Data	Checksum
0xAA	0x12		1	"Volume"	

"Volume": Volume value code to be set on a product. (0-100)

- Ack

Header	Command	ID	Data length	Ack/Nak	r-CMD	Val1	Checksum
0xAA	0xFF		3	'A'	0x12	"Volume"	

"Volume": Volume value code to be set on a product. (0-100)

- Nak

Header	Command	ID	Data length	Ack/Nak	r-CMD	Val1	Checksum
0xAA	0xFF		3	'N'	0x12	"ERR"	

"ERR" : A code showing what error has occurred.



## Input source control

- Function  
The input source of a product can be changed using a PC.
- Viewing input source state (Get Input Source Status)

Header	Command	ID	Data length	Checksum
0xAA	0x14		0	

Header	Command	ID	Data length	Data	Checksum
0xAA	0x14		1	"Input Source"	

"Input Source": An input source code to be set on a product.

0x0C	Input source
0x20	MagicInfo
0x21	HDMI1
0x22	HDMI1_PC
0x23	HDMI2
0x24	HDMI2_PC

— HDMI1\_PC and HDMI2\_PC cannot be used with the Set command. They only respond to "Get" commands.

— **MagicInfo** is only available with models that contain the **MagicInfo** function.

- Ack

Header	Command	ID	Data length	Ack/Nak	r-CMD	Val1	Checksum
0xAA	0xFF		3	'A'	0x14	"Input Source"	

"Input Source": An input source code to be set on a product.

- Nak

Header	Command	ID	Data length	Ack/Nak	r-CMD	Val1	Checksum
0xAA	0xFF		3	'N'	0x14	"ERR"	

"ERR" : A code showing what error has occurred.

## Screen mode control

- Function  
The screen mode of a product can be changed using a PC.  
Screen mode cannot be controlled when the **Video Wall** function is enabled.
- Viewing screen status (Get Screen Mode Status)

Header	Command	ID	Data length	Checksum
0xAA	0x18		0	

- Setting the picture size (Set Picture Size)

Header	Command	ID	Data length	Data	Checksum
0xAA	0x18		1	"Screen Mode"	

"Screen Mode": A code that sets the product status

0x01	16 : 9
0x04	Zoom
0x31	Wide Zoom
0x0B	4 : 3

- Ack

Header	Command	ID	Data length	Ack/Nak	r-CMD	Val1	Checksum
0xAA	0xFF		3	'A'	0x18	"Screen Mode"	

"Screen Mode": A code that sets the product status

- Nak

Header	Command	ID	Data length	Ack/Nak	r-CMD	Val1	Checksum
0xAA	0xFF		3	'N'	0x18	"ERR"	

"ERR": A code showing what error has occurred

## Screen size control

- Function  
The screen size of a product can be changed using a PC.
- Viewing the screen size (Get Screen Size Status)

Header	Command	ID	Data length	Checksum
0xAA	0x19		0	

- Ack

Header	Command	ID	Data length	Ack/Nak	r-CMD	Val1	Checksum
0xAA	0xFF		3	'A'	0x19	"Screen Size"	

"Screen Size": product screen size (range: 0 – 255, unit: inch)

- Nak

Header	Command	ID	Data length	Ack/Nak	r-CMD	Val1	Checksum
0xAA	0xFF		3	'N'	0x19	"ERR"	

"ERR": A code showing what error has occurred

## Video Wall Mode Control

- Function  
Video Wall mode can be activated on a product using a PC.  
This control is only available on a product whose Video Wall is enabled.
- Viewing video wall mode (Get Video Wall Mode)

Header	Command	ID	Data length	Checksum
0xAA	0x5C		0	

- Setting the video wall (Set Video Wall Mode)

Header	Command	ID	Data length	Data	Checksum
0xAA	0x5C		1	"Video Wall Mode"	

"Video Wall Mode": A code used to activate Video Wall mode on a product

1: Full

0: Natural

- Ack

Header	Command	ID	Data length	Ack/Nak	r-CMD	Val1	Checksum
0xAA	0xFF		3	'A'	0x5C	"Video Wall Mode"	

"Video Wall Mode": A code used to activate Video Wall mode on a product

- Nak

Header	Command	ID	Data length	Ack/Nak	r-CMD	Val1	Checksum
0xAA	0xFF		3	'A'	0x5C	"ERR"	

"ERR": A code showing what error has occurred

## Safety Lock

- Function  
PC can be used to turn the Safety Lock On function on or off on a product.  
This control is available regardless of whether or not the power is turned on.
- Viewing the safety lock state (Get Safety Lock Status)

Header	Command	ID	Data length	Checksum
0xAA	0x5D		0	

- Enabling or disabling safety lock (Set Safety Lock Enable / Disable)

Header	Command	ID	Data length	Data	Checksum
0xAA	0x5D		1	"Safety Lock"	

"Safety Lock": Safety lock code to be set on a product

1: ON

0: OFF

- Ack

Header	Command	ID	Data length	Ack/Nak	r-CMD	Val1	Checksum
0xAA	0xFF		3	'A'	0x5D	"Safety Lock"	

"Safety Lock": Safety lock code to be set on a product

- Nak

Header	Command	ID	Data length	Ack/Nak	r-CMD	Val1	Checksum
0xAA	0xFF		3	'N'	0x5D	"ERR"	

"ERR": A code showing what error has occurred

## Video Wall On

- Function  
Turn Video Wall on or off on the product from your computer.
- Get Video Wall On/Off Status

Header	Command	ID	Data length	Checksum
0xAA	0x84		0	

- Set Video Wall On/Off

Header	Command	ID	Data length	Data	Checksum
0xAA	0x84		1	V.Wall_On	

- V.Wall\_On: Video Wall code to be assigned to the product

1: Video Wall ON

0: Video Wall OFF

- Ack

Header	Command	ID	Data length	Ack/Nak	r-CMD	Val1	Checksum
0xAA	0xFF		3	'A'	0x84	V.Wall_On	

V.Wall\_On : Same as above

- Nak

Header	Command	ID	Data length	Ack/Nak	r-CMD	Val1	Checksum
0xAA	0xFF		3	'N'	0x84	ERR	

"ERR": A code showing what error has occurred

## Video Wall User Control

- Function  
Turn the Video Wall function on or off on the product from your computer.
- Get Video Wall Status

Header	Command	ID	Data length	Checksum
0xAA	0x89		0	

- Set Video Wall

Header	Command	ID	Data length	Val1	Val2	Checksum
0xAA	0x89		2	Wall_Div	Wall_SNo	

Wall\_Div: Video Wall Divider code assigned to the product

## 10x10 Video Wall Model

	1	2	3	4	5	6	7	8	9	10	11	12	13	14	15
<b>Off</b>	0x00	0x00	0x00	0x00	0x00	0x00	0x00	0x00	0x00	0x00	0x00	0x00	0x00	0x00	0x00
<b>1</b>	0x11	0x12	0x13	0x14	0x15	0x16	0x17	0x18	0x19	0x1A	0x1B	0x1C	0x1D	0x1E	0x1F
<b>2</b>	0x21	0x22	0x23	0x24	0x25	0x26	0x27	0x28	0x29	0x2A	0x2B	0x2C	0x2D	0x2E	0x2F
<b>3</b>	0x31	0x32	0x33	0x34	0x35	0x36	0x37	0x38	0x39	0x3A	0x3B	0x3C	0x3D	0x3E	0x3F
<b>4</b>	0x41	0x42	0x43	0x44	0x45	0x46	0x47	0x48	0x49	0x4A	0x4B	0x4C	0x4D	0x4E	0x4F
<b>5</b>	0x51	0x52	0x53	0x54	0x55	0x56	0x57	0x58	0x59	0x5A	0x5B	0x5C	0x5D	0x5E	0x5F
<b>6</b>	0x61	0x62	0x63	0x64	0x65	0x66	0x67	0x68	0x69	0x6A	0x6B	0x6C	0x6D	0x6E	0x6F
<b>7</b>	0x71	0x72	0x73	0x74	0x75	0x76	0x77	0x78	0x79	0x7A	0x7B	0x7C	0x7D	0x7E	N/A
<b>8</b>	0x81	0x82	0x83	0x84	0x85	0x86	0x87	0x88	0x89	0x8A	0x8B	0x8C	N/A	N/A	N/A
<b>9</b>	0x91	0x92	0x93	0x94	0x95	0x96	0x97	0x98	0x99	0x9A	0x9B	N/A	N/A	N/A	N/A
<b>10</b>	0xA1	0xA2	0xA3	0xA4	0xA5	0xA6	0xA7	0xA8	0xA9	0xAA	N/A	N/A	N/A	N/A	N/A
<b>11</b>	0xB1	0xB2	0xB3	0xB4	0xB5	0xB6	0xB7	0xB8	0xB9	N/A	N/A	N/A	N/A	N/A	N/A
<b>12</b>	0xC1	0xC2	0xC3	0xC4	0xC5	0xC6	0xC7	0xC8	N/A	N/A	N/A	N/A	N/A	N/A	N/A
<b>13</b>	0xD1	0xD2	0xD3	0xD4	0xD5	0xD6	0xD7	N/A	N/A	N/A	N/A	N/A	N/A	N/A	N/A
<b>14</b>	0xE1	0xE2	0xE3	0xE4	0xE5	0xE6	0xE7	N/A	N/A	N/A	N/A	N/A	N/A	N/A	N/A
<b>15</b>	0xF1	0xF2	0xF3	0xF4	0xF5	0xF6	N/A	N/A	N/A	N/A	N/A	N/A	N/A	N/A	N/A

Wall\_SNo: Product Number code assigned to the product

### 10x10 Video Wall Model : ( 1 ~ 100)

Set Number	Data
1	0x01
2	0x02
...	...
99	0x63
100	0x64

- Ack

Header	Command	ID	Data length	Ack/Nak	r-CMD	Val1	Val2	Checksum
0xAA	0xFF		4	'A'	0x89	Wall_Div	Wall_SNo	

- Nak

Header	Command	ID	Data length	Ack/Nak	r-CMD	Val1	Checksum
0xAA	0xFF		3	'N'	0x89	ERR	

"ERR": A code showing what error has occurred

# Chapter 03

## Connecting and Using a Source Device

### Before Connecting

#### Pre-connection Checkpoints

- Before connecting a source device, read the user manual provided with it.  
The number and locations of ports on source devices may differ from device to device.
- Do not connect the power cable until all connections are completed.  
Connecting the power cable during connection may damage the product.
- Connect the sound ports correctly: left = white and right = red.
- Check the types of ports at the back of the product you want to connect.

## Before connecting cables

— The colour and shape of parts may differ from what is shown. Specifications are subject to change without notice to improve quality.

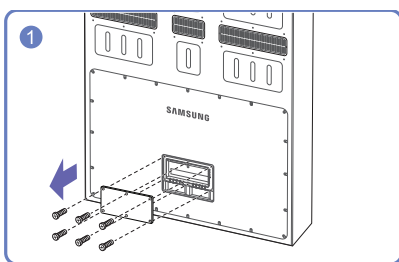
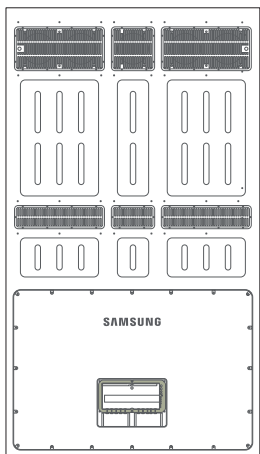

Unfasten the screws, then remove the cover.

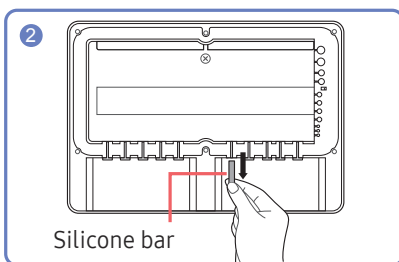

Remove the appropriate silicone bar for the thickness of the cable to connect.

Different hole sizes and corresponding cable thickness for each:

- 7 Ø hole x 1: Insert the 7 Ø cable
- 5.5 Ø hole x 6: Insert the 5.5 Ø cable
- 3 Ø hole x 2: Insert the 3 Ø cable
- 8.5 Ø hole x 1: Insert the 8.5 Ø cable

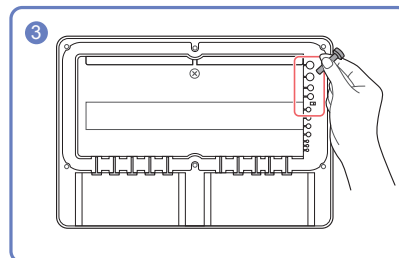

Insert and keep the removed silicone bar in the marked area to ensure it is not lost.

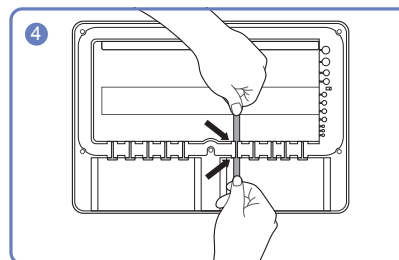

Insert the appropriate cable into the hole from which the silicone bar was removed.

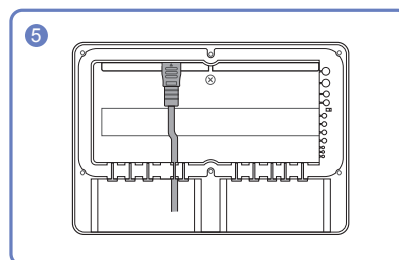

The cable should be connected as shown.

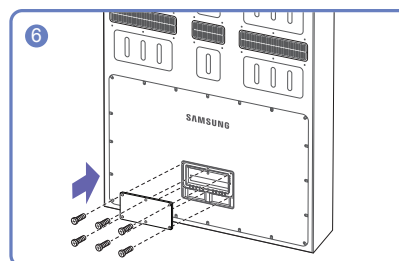

Close the cover, then fasten the screws.

- After all the cables are connected, make sure to close the cover and fasten the screws to ensure it is water tight.
- Recommended torque :10 - 12 kgf.cm



## Power cable connection guide

— The colour and shape of parts may differ from what is shown. Specifications are subject to change without notice to improve quality.

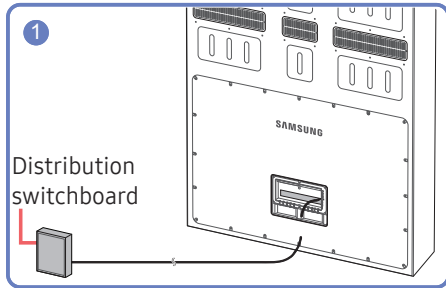

Prepare the waterproof power cable whose diameter is 8.5 mm for 15 A.

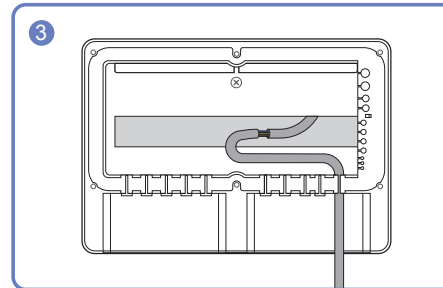

Put the soldered (connected) part of the power cables inside the product.

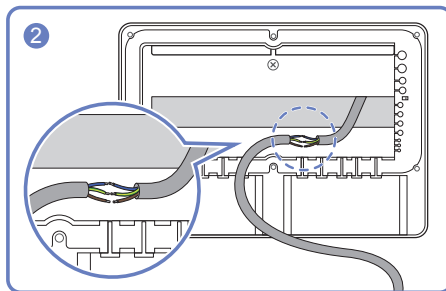

Connect the two power cables to each other. Solder and insulate the connected part.

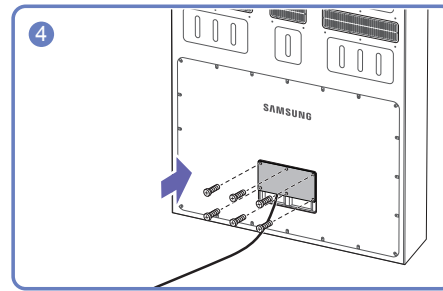

















Close the rear cover and fasten the screws.

### Different power cable colours by country

When connecting an external power cable, be sure to match the colours of its wires with those of the 3 wires inside the product's power cable. The meaning (Neutral, Live or Ground) of each wire colour of the external power cable may differ depending on the country.

— Be sure to refer to the following table to correctly connect wires by the same meaning:

Model Name	Neutral	Live	Ground	Country
OH75A	BLUE 	BROWN 	GREEN/YELLOW 	
	WHITE 	BLACK 	GREEN  or GREEN/YELLOW 	America
	BLUE 	BROWN 	GREEN/YELLOW 	Europe
	BLACK 	RED 	GREEN/YELLOW 	India
	WHITE 	BLACK 	GREEN  or GREEN/YELLOW 	Taiwan & Japan

## Connecting to a PC

- Do not connect the power cable before connecting all other cables. Ensure you connect a source device first before connecting the power cable.
  - A PC can be connected to the product in a variety of ways. Select a connection method suitable for your PC.
- Connecting parts may differ in different products.

### Connection Using an HDMI Cable

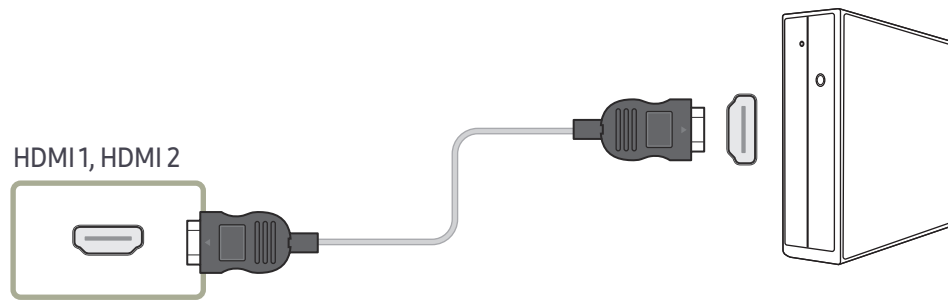

### Connection Using an HDMI-DVI Cable

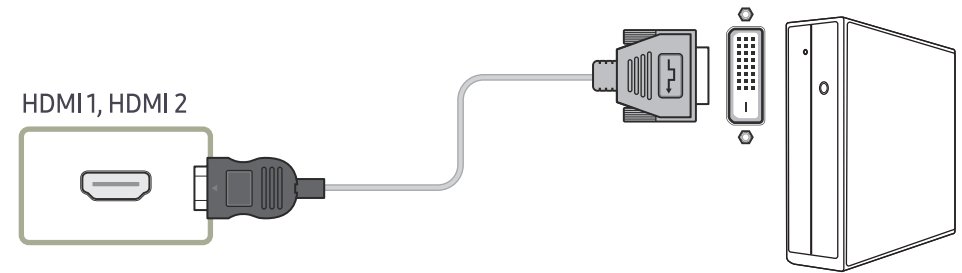

---

## Connection Using an DP Cable

— Connecting parts may differ in different products.

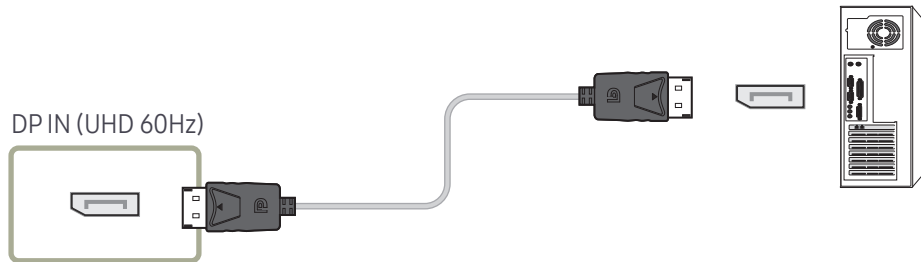

- Precautions for using DP

- Some graphics cards that are not compliant with the DP standard may prevent the Windows Booting/Bios screen from being displayed when the product is in power-saving mode. If this is the case, make sure to turn on the product first before turning on your PC.
- Using a DP cable that is not VESA compliant may cause the product to function improperly. Samsung shall not be held responsible for any issues from using a cable that is not VESA compliant.  
Make sure to use a DP cable that is VESA compliant.
- To use the optimal resolution (3840 x 2160 @ 60Hz) when the input source is **DisplayPort**, using a DP cable shorter than 5m is recommended.
- Disabling power-saving mode when the input source is **DisplayPort** may import new resolution information and reset the task window size or location.

## Connecting to a Video Device

- Do not connect the power cable before connecting all other cables. Ensure you connect a source device first before connecting the power cable.
- You can connect a video device to the product using a cable.
  - Connecting parts may differ in different products.
  - Press the SOURCE button on the remote control to change the source.

## Connection Using an HDMI-DVI Cable

Supported resolutions include 1080p (50/60Hz), 720p (50/60Hz), 480p, and 576p.

- The appearance may differ depending on the product.
- Connecting parts may differ in different products.

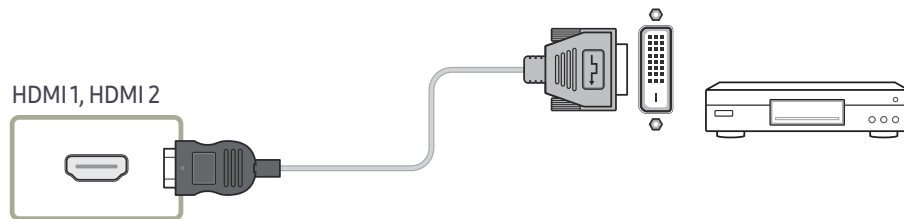

## Connection Using an HDMI Cable

- The appearance may differ depending on the product.
- Connecting parts may differ in different products.

### Using an HDMI cable or HDMI to DVI Cable (up to 1080p)

- For better picture and audio quality, connect to a digital device using an HDMI cable.
- An HDMI cable supports digital video and audio signals, and does not require an audio cable.
  - To connect the product to a digital device that does not support HDMI output, use an HDMI-DVI and audio cables.
- The picture may not display normally (if at all) or the audio may not work if an external device that uses an older version of HDMI mode is connected to the product. If such a problem occurs, ask the manufacturer of the external device about the HDMI version and, if out of date, request an upgrade.
- Be sure to use an HDMI cable with a thickness of 14 mm or less.
- Be sure to purchase a certified HDMI cable. Otherwise, the picture may not display or a connection error may occur.
- A basic high-speed HDMI cable or one with ethernet is recommended. This product does not support the ethernet function via HDMI.

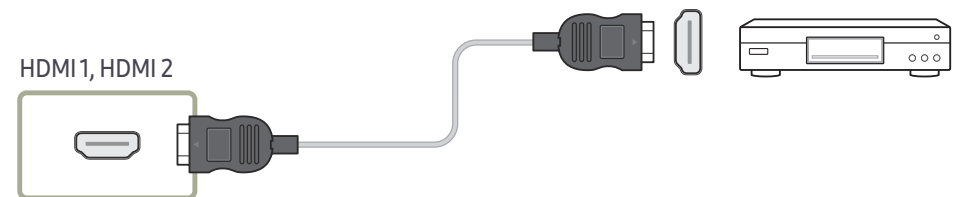

## Connecting to an Audio System

— Connecting parts may differ in different products.

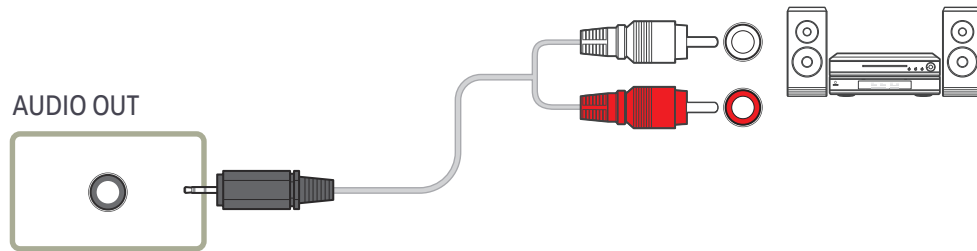

## Connecting the LAN Cable

— Connecting parts may differ in different products.

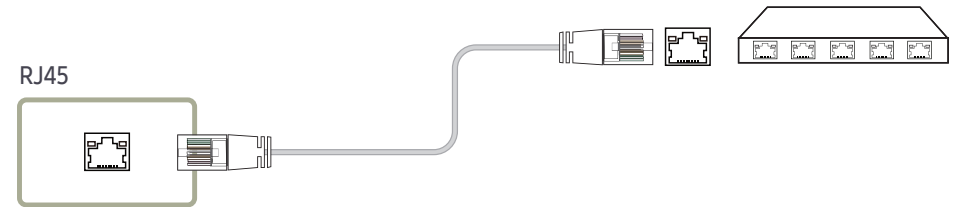

- Use Cat7(\*STP Type) cable for the connection. (10/100 Mbps)  
\*Shielded Twisted Pair

# Changing the Input source

## Source

### SOURCE

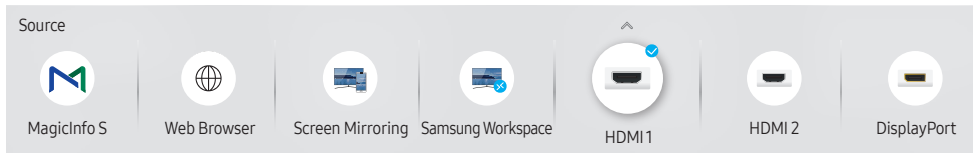

– The displayed image may differ depending on the model.

**Source** allows you to select a variety of sources and change source device names.

You can display the screen of a source device connected to the product. Select a source from source list to display the screen of the selected source.

- The input source can also be changed by using the **SOURCE** button on the remote control.
- The screen may not display correctly if an incorrect source is selected for the source device you want to convert to.

## Edit

**SOURCE** → ▲ → **Edit** → ENTER ↵

Edit the name and device type of a connected external device.

- The list can include the following source devices. Source devices on the list differ depending on the selected source.  
**HDMI 1 / HDMI 2 / DisplayPort / Cable Box / Game Console / PC / Blu-ray player**
- You cannot edit the following sources.  
**MagicInfo S / Web Browser / Screen Mirroring / Samsung Workspace**



---

## Web Browser

SOURCE →  Web Browser → ENTER 

— Connect the network to access the Internet from the product like accessing the Internet from a computer.

### Settings

SOURCE →  Web Browser → ▲ → Settings → ENTER 

#### Refresh Interval

Set the time for the web browser to wait before returning to the home page.

- Off / 5 min / 10 min / 15 min / 30 min

#### Zoom

Set the zoom scale to apply when the web browser is refreshed.

- 50% / 75% / 100% / 125% / 150% / 200% / 300%

#### Home Page

Set the website to display when the web browser is refreshed.

- Samsung Display / Custom

#### Custom

Enter the URL to set as the home page.

- Enter URL

— Available only when Home Page is set to Custom.

## Advanced Settings

---

### General

---

Hide Tabs and Toolbar automatically	If the browser tabs, menu or toolbar are not used for a while, they will automatically disappear. To make them appear again, move the pointer or focus to the top of the screen.
-------------------------------------	--

- Use / Do not use

---

Hide Cursor in Touch Mode	Hide the cursor to prevent interference with touch operation.
---------------------------	---

- Use / Do not use

---

Pop-up Blocker	Make your browsing experience more pleasant by blocking pop-up windows.
----------------	---

- Use / Do not use

---

Proxy Server	Configure a proxy server for the web browser.
--------------	---

- Use / Do not use

---

Reset Settings	All your customised Web Browser settings will be reset to their default values. Your bookmarks and history won't be affected.
----------------	---

---

### Search Engine

---

If you enter a keyword in the URL/keyword input field, Web Browser will open the Search Results page. Choose the search engine you want to use.

- Google / Bing
-

---

## Privacy & Security

---

<b>Do Not Track</b>	Ask websites not to track you. <ul style="list-style-type: none"><li>• Use / Do not use</li></ul>
<b>Delete History</b>	Delete your entire browsing history.
<b>JavaScript</b>	Allow all sites to run JavaScript for a better browsing experience. <ul style="list-style-type: none"><li>• Use / Do not use</li></ul>
<b>Delete browsing data</b>	Delete all browsing data such as cookies, cached images and data. Your bookmarks and history won't be affected.

---

## Encoding

---

<b>Encoding</b>	Choose an encoding method for web pages. The current setting is Auto. <ul style="list-style-type: none"><li>• Auto / Manual (Current : Unicode)</li></ul>
-----------------	---

---

## About

---

Display the current version of Web Browser.

---

## Read Before Using the Web Browser Function

Read this information before using the Web Browser function.

- File download is not supported.
- The **Web Browser** function may not be able to access certain websites, including websites operated by certain companies.
- The product does not support playback of flash videos.
- E-commerce for online purchases is not supported.
- ActiveX is not supported.
- Only a limited number of fonts are supported. Certain symbols and characters may not be displayed properly.
- The response to remote commands and the resulting on-screen display may be delayed while a web page is loading.
- Loading a web page may be delayed or suspended completely depending on the status of the participating systems.
- Copy and paste operations are not supported.
- When composing an email or a simple message, certain functions such as the font size and color selection may not be available.
- There is a limit to the number of bookmarks and the size of the log file that can be saved.
- The number of windows that can be opened concurrently is limited.
- Web browsing speed will differ with the network environment.
- Browsing history is saved from latest to oldest, with the oldest entries being overwritten first.
- Depending on the types of video/audio codecs supported, you may not be able to play certain HTML5 video and audio files.
- Video sources from PC-optimized streaming service providers may not play properly on our proprietary **Web Browser** browser.



---

## Screen Mirroring

— This function may not be supported depending on the model.

## Samsung Workspace

— Make sure that the product is connected to the network.

— Be sure to connect your keyboard and mouse before starting this function.

### Samsung Workspace

SOURCE →  Samsung Workspace → ENTER 

Access to remote PC and your work resources with this function.

- **Remote PC:** This function allows you to connect your product to a remote PC or a cloud server.
  - Only PCs or Cloud Servers running on macOS/Windows 7 Pro or newer are supported.
- **Office 365:** Provides access to **Office 365** features from Microsoft.
- **VMware Horizon:** Provides access to **VMware Horizon** to businesses operating the VMware infrastructure with a Horizon account.

# Chapter 04

## Using MDC

Multiple display control "MDC" is an application that allows you to easily control multiple display devices simultaneously using a PC. For details on how to use the MDC programme, refer to Help after installing the programme. The MDC programme is available on the website.

After you press the **Never expired** button following the **Expired** button, the product checks its status for about a minute. To run a command, try it after a minute.

## MDC Programme Installation/Uninstallation

### Installation

— MDC installation can be affected by the graphics card, mother board and network conditions.

- 1 Click the **MDC Unified** installation programme.
- 2 Select a language for installation. Next, click **"OK"**.
- 3 When the **"Welcome to the InstallShield Wizard for MDC\_Unified"** screen appears, click **"Next"**.
- 4 In the **"License Agreement"** window displayed, select **"I accept the terms in the license agreement"** and click **"Next"**.
- 5 In the displayed **"Customer Information"** window, fill out all the information fields and click **"Next"**.

- 6 In the displayed **"Destination Folder"** window, select the directory path you want to install the programme in and click **"Next"**.
  - If the directory path is not specified, the programme will be installed in the default directory path.
- 7 In the displayed **"Ready to Install the Program"** window, check the directory path to install the programme in and click **"Install"**.
- 8 Installation progress will be displayed.
- 9 Click **"Finish"** in the displayed **"InstallShield Wizard Complete"** window.
  - Select **"Launch MDC Unified"** and click **"Finish"** to run the MDC programme immediately.
- 10 The **MDC Unified** shortcut icon will be created on the desktop after installation.
  - The MDC execution icon may not be displayed depending on the PC system or product specifications.
  - Press F5 if the execution icon is not displayed.

### Uninstallation

- 1 Select **Settings > Control Panel** on the **Start** menu and double-click **Add/Delete** programme.
- 2 Select **MDC Unified** from the list and click **Change/Remove**.

---

## Connecting to MDC

### Using MDC via RS-232C (serial data communications standards)

An RS-232C serial cable must be connected to the serial ports on the PC and monitor.

— The appearance may differ depending on the product.

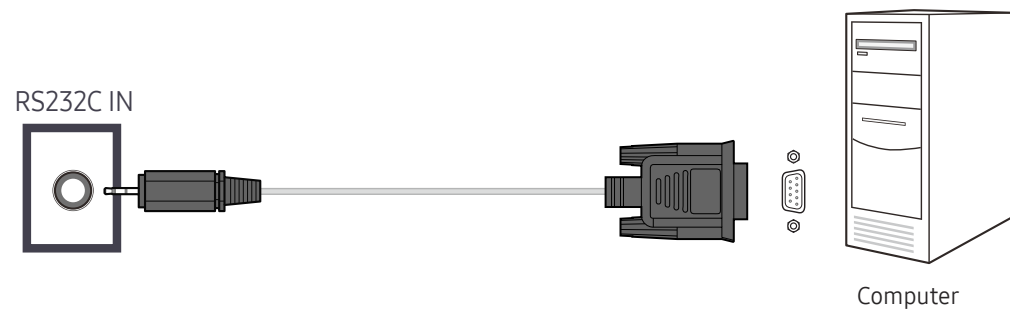

# Using MDC via Ethernet

Enter the IP for the primary display device and connect the device to the PC. Display devices can be connected to each other using a LAN cable.

## Connection using a direct LAN cable

- The appearance may differ depending on the product.
- Multiple products can be connected using the RJ45 port on the product and the LAN ports on the HUB.

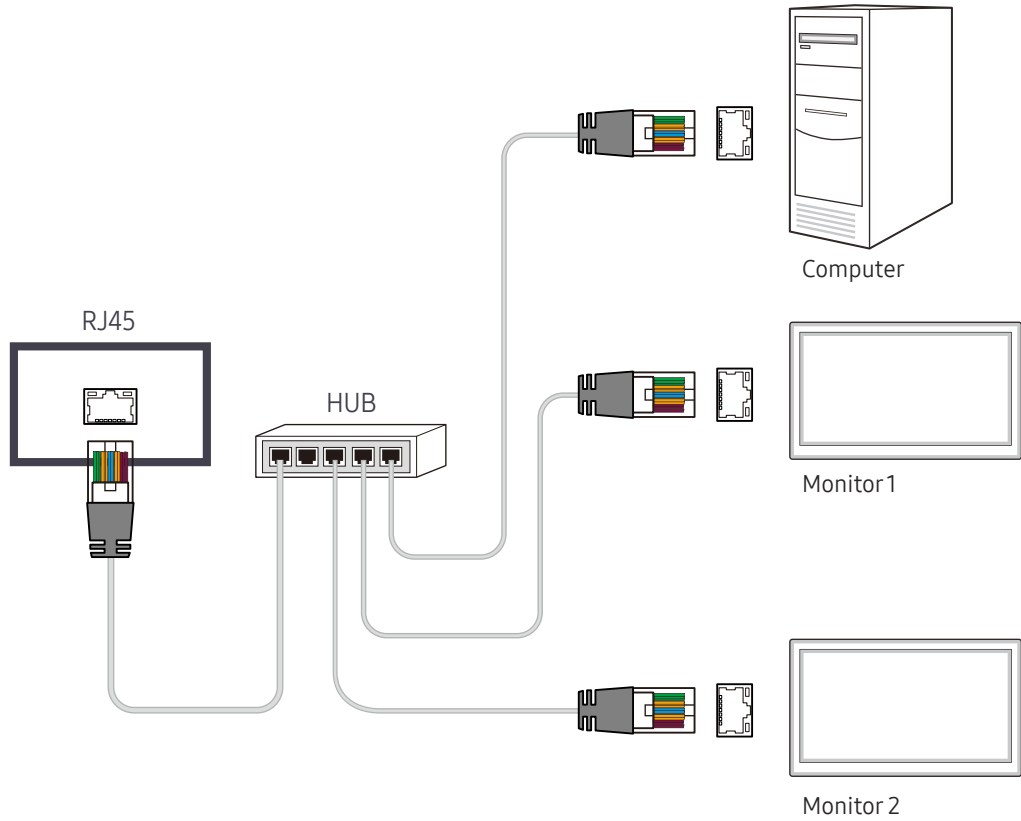

# Chapter 05

## Player feature

Accessible using the HOME button on the remote control.

### Player

HOME  → **Player** → ENTER 

Play a range of content such as channels with schedules assigned, templates or files.

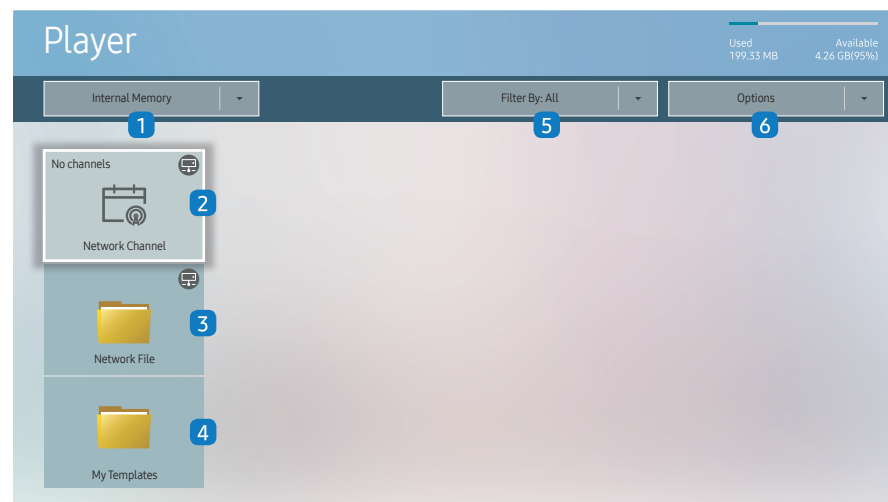

- The displayed image may differ depending on the model.
- To use the **Player** feature, set **Play via** to **MagicInfo** in **System**.  
(MENU  → **System** → **Play via** → **MagicInfo**)
- You must set **Clock Set** before you can use this feature.

No.	Description
1	Select between internal or external memory.
2	Play content, templates and schedules configured on the server. <ul style="list-style-type: none"><li>• You can view whether the server is connected (approval) in the <b>Player</b> screen. To view whether the server is connected when a Network Channel is running, press <b>INFO</b> on the remote control.</li></ul>
3	Play content stored on the server.
4	Play templates stored in <b>My Templates</b> folder in the Internal Memory.
5	Select a content type as criterion to search for a desired content list.
6	Set different options for <b>Player</b> .

### Viewing content

- 1 Select either internal or external memory. The files saved in the selected memory appear.
- 2 Select the desired file. The content appears on the screen. (For more information on compatible file formats, see the "File formats compatible with Player" section.)

## When content is running

### Control buttons on the remote control

You can play, pause, or skip the content on the playlist by pressing buttons on the remote control.

Button	Function
TOOLS	Brings up the menu bar.
INFO	Displays the general information of the content.
▶	Goes to next file or page.
◀	Goes to previous file or page.
⏪ / ▶ / ⏸	Plays or pauses slide show or video content.
■	Stops displaying content and goes to the <b>Player</b> screen.
◀◀	Rewinds the video content.
▶▶	Fast forwards the video content.

- If there is only one image file in the Internal Memory or USB, the Slide Show will not play.
- If the name of a folder is too long on the USB, you cannot select the folder.
- **Portrait** option for **Content Orientation** is not available for contents with a resolution higher than 3840 x 2160.
- **Content Size** for videos with a resolution higher than 3840 x 2160 supports **Full Screen** only.

## Available menu

Press the TOOLS button on the remote control during content playback to configure settings.

Menu	Description
<b>Playlist</b>	View a list of content items currently playing.
<b>Channel List</b>	<b>Network Channel</b> / <b>Internal Channel</b> / USB
<b>Repeat All / Repeat One</b>	Set the repeat mode.
<b>Background Music</b>	Set the background music to be played when content is running.
<b>Reset</b>	Reset the background music.
<b>Pause</b>	Pause the background music.
<b>Prev</b>	Play the previous background music on the list.
<b>Next</b>	Play the next background music on the list.

- **Reset, Pause, Prev, Next** only appear when the background music is set.

---

## File Formats Compatible with Player

- Supported file systems include FAT32 and NTFS.
- A file with a vertical and horizontal resolution larger than the maximum resolution cannot be played. Check the vertical and horizontal resolution of the file.
- Check the supported video and audio Codec types and Versions.
- Check the supported file versions.
  - PowerPoint version up to 97 – 2013 is supported
- For USB-**Internal Memory** file transfer, click **Options** → **Send**.
  - Location of template files
    - **Internal Memory** → USB transfer: USB → under MagicinfoSlide folder
    - USB → **Internal Memory** transfer: **Internal Memory** → under My Templates folder
  - Location of other files (non-template)
    - **Internal Memory** → USB transfer: USB → under MagicinfoSlide folder
    - USB → **Internal Memory** transfer: Under the root folder

## Network Schedule Multiframe

### Playback restrictions



- 1 to 3 FHD video files can be played simultaneously or only one UHD video file and one FHD video file at a time. In portrait playback mode, 3 FHD video files can be played simultaneously or only one UHD video file at a time.
- For **Office** files (PPT and Word files) and **PDF** files, only one file type is supported at a time.
- LFD(\*.LFD) files are not supported.
- Contents with a resolution higher than 3840 x 2160 are not supported.

### Sound output restrictions

- More than one sound output cannot be used.
- Playback priority: network BGM → local BGM → video file in the main frame selected by the user
  - Network BGM: Settings can be configured when creating a server schedule.
  - Local BGM: BGM settings can be configured using the tools displayed after the **TOOLS** button is pressed during **Player** playback.
  - User-selected main frame: Main frame settings can be configured when creating a server schedule.

## Template files(\*.LFD)

### Restrictions

- Check that you have **Contents** and **Schedules** folders published to the USB storage device.
  - A properly published content appears as Published Content  in the USB device.
  - When copying a content you published to a USB device (Published Content ) to the **Internal Memory**, the content appears in **Internal Memory** as Published Content  only. **Contents** and **Schedules** folders are not visible under **Internal Memory**.

### Playback restrictions

- A maximum of two video (**Video**) files can be played.
- For **Office** files (PPT and Word files) and **PDF** files, only one file type is supported at a time.
- When playing more than one video files simultaneously, make sure that the display areas are not overlapping one another.

### Sound output restrictions

- More than one sound output cannot be used.
- Playback priority: network BGM → local BGM → video file in the main frame selected by the user

## Video codecs

File Extension	Container	Video Codec	Resolution	Frame rate (fps)	Bit rate (Mbps)	Audio Codec		
*.avi	AVI	H.264 BP/MP/HP	4096 x 2160	4096 x 2160: 30	60	Dolby Digital		
*.mkv	MKV			3840 x 2160: 60		AC3		
*.asf	ASF	HEVC (H.265 - Main, Main10)	3840 x 2160	60	80	LPCM		
*.wmv	MP4	Motion JPEG		30		ADPCM(IMA, MS)		
*.mp4	3GP		1920 x 1080	60	20	AAC		
*.mov	MOV	MVC				HE-AAC		
*.3gp	FLV	MPEG4 SP/ASP				WMA		
*.vro	VRO	Window Media Video v9 (VC1)				DD+		
*.mpg	VOB					MPEG(MP3)		
*.mpeg	PS	MPEG2				AC-4		
*.ts	TS	MPEG1				G.711(A-Law, $\mu$ -Law)		
*.tp	SVAF	Microsoft MPEG-4 v1, v2, v3				30		OPUS
*.trp		Window Media Video v7(WMV1), v8(WMV2)						
*.flv		H 263 Sorenson						
*.vob								
*.svi		VP6						
*.m2ts								
*.mts								
*.webm	WebM	VP8	1920 x 1080	60	20	Vorbis		
		VP9	3840 x 2160	3840 x 2160: 60	80			
*.rmvb	RMVB	RV8/9/10 (RV30/40)	1920 x 1080	60	20	RealAudio 6		



---

## Other restrictions

- Codecs may not function properly if there is a problem with the content.
- Video content does not play or does not play correctly if there is an error in the content or container.
- Sound or video may not work if they have standard bit rates/frame rates above the TV's compatibility ratings.
- If the Index Table is has an error, the Seek (Jump) function will not work.
- When playing video over a network connection, the video may not play smoothly because of data transmission speeds.
- Some USB/digital camera devices may not be compatible with the TV.
- HEVC codec is only available in MKV / MP4 / TS containers.
- The MVC codec is supported partly.

## Video decoders

- H.264 UHD is supported up to Level 5.1, and H.264 FHD is supported up to Level 4.1. (TV does not support FMO / ASO / RS)
- HEVC UHD is supported up to Level 5.1, and HEVC FHD is supported up to Level 4.1.
- HEVC 8K is supported up to Level 6.1.
- VC1 APL4 is not supported.
- GMC 2 or above is not supported.
- When a single video file is playing, Seamless mode is not supported under the following conditions:
  - Incompatible codec (MVC, VP3, MJPEG) ↔ Incompatible codec
  - Incompatible codec ↔ Compatible codec
  - The resolution is different from that of the monitor
  - The frequency is different from that of the monitor

## Audio decoders

- WMA is supported up to 10 Pro 5.1 channels, M2 profile.
- WMA1, WMA lossless / Voice are not supported.
- QCELP and AMR NB/WB are not supported.
- Vorbis is supported for up to 5.1 channels.
- Dolby Digital Plus is supported for up to 5.1 channels.
- The supported sample rates are 8, 11.025, 12, 16, 22.05, 24, 32, 44.1, and 48 kHz, and differ with the codec.

## Image

- Compatible image file format: JPEG, PNG, BMP
  - 32-bit, 24-bit and 8-bit BMP files are supported.
- Supported maximum resolution: 7680 x 4320 (JPEG), 4096 x 4096 (PNG, BMP)
  - When playing 10 files in one LFD file - 5120 x 5120
- Supported maximum file size: 20MB
- Supported **Slideshow Effect**: 9 effects  
(**Fade1, Fade2, Blind, Spiral, Checker, Linear, Stairs, Wipe, Random**)

---

## Power Point

- Compatible document file formats
  - Extension : ppt, pptx
  - Version : Office 97 ~ Office 2013
- Functions not supported
  - Animation effect
  - 3D shapes (which will be displayed in 2D)
  - Header and footer (some subitems are not supported)
  - Word Art
  - Align
    - A group alignment error may occur
  - Office 2007
    - SmartArt is not fully supported. 97 out of 115 subitems are supported.
  - Object insertion
  - Half-width characters
  - Letter spacing
  - Charts
  - Vertical text
    - Some subitems are not supported
  - Slide notes and handout



## PDF

- Compatible document file formats
  - Extension : pdf
- Functions not supported
  - Content less than 1 pixel not supported because of performance degradation issue.
  - Masked Image, Tiled Image content not supported.
  - Content with Rotated Text, not supported.
  - 3D Shadow Effects not supported.
  - Some characters not supported (Special characters may be corrupted)

## WORD

- Compatible document file formats
  - Extension : .doc, .docx
  - Version : Office 97 ~ Office 2013
- Functions not supported
  - Page background effect
  - Some paragraph styles
  - Word Art
  - Align
    - A group alignment error may occur
  - 3D shapes (which will be displayed in 2D)
  - Office 2007
    - SmartArt is not fully supported. 97 out of 115 subitems are supported.
  - Charts
  - Half-width characters
  - Letter spacing
  - Vertical text
    - Some subitems are not supported
  - Slide notes and handout

# Schedule

HOME  → Schedule → ENTER 

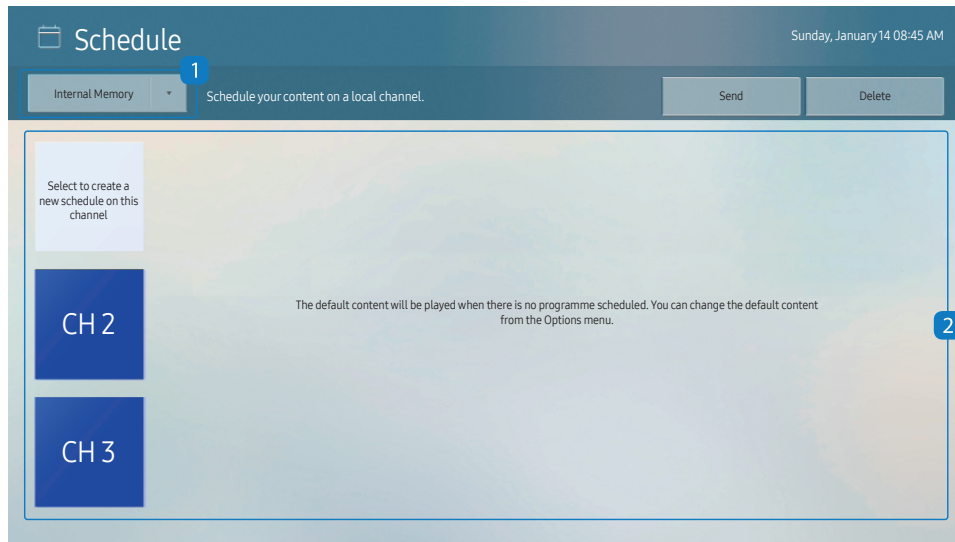

– The displayed image may differ depending on the model.

You can check the schedule imported from a selected storage device.

No.	Description
1	Select the saved location of the schedule.
2	Create/Edit/Delete/View schedule of content playback.

# Clone Product

HOME  → Clone Product → ENTER 

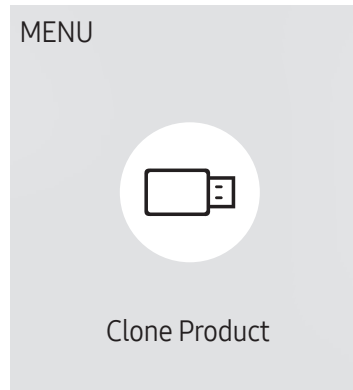

– The displayed image may differ depending on the model.

Export settings on the product to an external storage device. You can also import settings from an external storage device.

This option is useful when assigning the same settings to several products.

## When a duplicate file is not found on the external storage device

- 1 Connect the external storage device, then run the **Clone Product** function.
- 2 The **No cloning file found on the external storage device. Export this device's settings to the external storage device?** message appears.
- 3 Select **Export** to export the settings.

## When a duplicate file is found on the external storage device

- 1 Connect the external storage device, then run the **Clone Product** function.
- 2 The **Cloning file found. Please select an option.** message appears.

Run the **Import from External Storage** or **Export to External Storage** function.

- **Import from External Storage:** Copy settings saved on an external storage device to the product.
  - After configuration is complete, the product is rebooted automatically.
- **Export to External Storage:** Copy settings on the product to an external storage device.

# ID Settings

HOME  → ID Settings → ENTER 

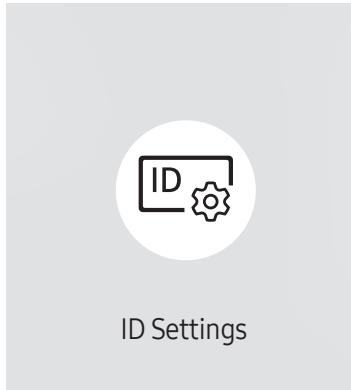

– The displayed image may differ depending on the model.

Assign an ID to a set.

## Device ID

Set a unique ID number for each product. (Range: 0~224)

- Press ▲/▼ to select a number, and press .
- Enter the number you want using the number buttons on the remote control.

## PC Connection Cable

Select which type of cable you are using to connect the display to the PC.

- **RS232C cable**  
Communicate with MDC via the RS232C cable.
- **RJ-45 (LAN) Cable**  
Communicate with MDC via the RJ45 cable.

---

## Video Wall

HOME  → Video Wall → ENTER 

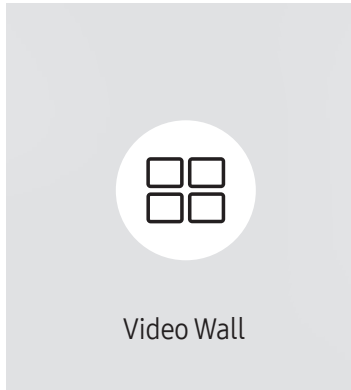

---

– The displayed image may differ depending on the model.

Customise the layout of multiple displays that are connected to form a video wall.

In addition, display part of a whole picture or repeat the same picture on each of the connected multiple displays.

To display multiple images, refer to MDC Help or the MagicInfo user guide. Some models may not support the MagicInfo function.

## Video Wall

You can activate or deactivate **Video Wall**.

To organise a video wall, select **On**.

- **Off / On**

## Horizontal x Vertical

This feature automatically splits a videowall display based on a videowall matrix configuration.

Enter the videowall matrix.

The videowall display is split based on the configured matrix. The number of vertical or horizontal display devices can be set within the range 1 and 15.

- A videowall display can be split into a maximum of 225 screens.
- The **Horizontal x Vertical** option is only enabled when **Video Wall** is set to **On**.

---

## Screen Position

To rearrange split screens, adjust the number for each product in the matrix using the **Screen Position** feature.

Selecting **Screen Position** will display the videowall matrix with the numbers assigned to the products that form the videowall.

To rearrange products, use the direction buttons on the remote control to move a product to another desired number. Press the  button.

- **Screen Position** allows you to split the screen into a maximum of 225 views (15 x 15).
- The **Screen Position** option is only enabled when **Video Wall** is set to **On**.
- To use the function, make sure **Horizontal x Vertical** is configured.

## Format

Select how to display images on the videowall display.

- **Full**: Display images in full screen with no margin.
  - **Natural**: Display images in the original aspect ratio without enlarging or reducing the size.
- The **Format** option is only enabled when **Video Wall** is set to **On**.

## Network Status

HOME  → **Network Status** → ENTER 

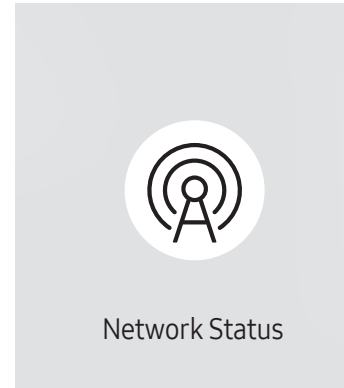

- 
- The displayed image may differ depending on the model.
- Check the current network and Internet connection.

## On/Off Timer

HOME  → On/Off Timer → ENTER 

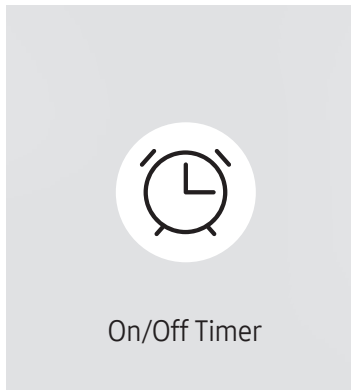

– The displayed image may differ depending on the model.

– You must set **Clock Set** before you can use this feature.

## On Timer

Set **On Timer** so that your product turns on automatically at a time and on a day of your choice. The power is turned on with the specified volume or input source.

**On Timer**: Set the on timer by making a selection from one of the seven options. Ensure you set the current time first.

(**On Timer1** ~ **On Timer7**)

- While the internal/USB memory option can be used with **On Timer** for **MagicInfo** mode, it is recommended to use an internal memory.
- Proper operation of **On Timer** feature cannot be guaranteed if used with a battery powered USB device, which can take longer to be recognised.
- **Setup**: Select **Off**, **Once**, **Everyday**, **Mon~Fri**, **Mon~Sat**, **Sat~Sun** or **Manual**. If you select **Manual**, you can choose the days you want **On Timer** to turn on your product.
  - The check mark indicates days you've selected.
- **Time**: Set the hour and minute. Use the number buttons or the up and down arrow keys to enter numbers. Use the left and right arrow buttons to change entry fields.
- **Volume** (For models with built-in speakers): Set the desired volume level. Use the up and down arrow buttons to change the volume level.
- **Source**: Select the input source of your choice.
- **Content** (when the **Source** is set to **Internal/USB** for **MagicInfo** mode): From the USB device or internal memory, select a file (e.g. music, photo, or video) to play just after the product is turned on.



## Off Timer

Set the off timer (**Off Timer**) by making a selection from one of the seven options. (**Off Timer1 ~ Off Timer 7**)

- **Setup:** Select **Off**, **Once**, **Everyday**, **Mon~Fri**, **Mon~Sat**, **Sat~Sun** or **Manual**. If you select **Manual**, you can choose the days you want **Off Timer** to turn off your product.
  - The check mark indicates days you've selected.
- **Time:** Set the hour and minute. Use the number buttons or the up and down arrow keys to enter numbers. Use the left and right arrow buttons to change entry fields.

## Holiday Management

Timer will be disabled during a period specified as a holiday.

- **Add Holiday:** Specify the period you want to add as a holiday. Select the start and end dates of the holiday you want to add using the ▲/▼ buttons, and click the **Done** button. The period will be added to the list of holidays.
  - **Start Date:** Set the start date of the holiday.
  - **End Date:** Set the end date of the holiday.
- **Delete:** Delete selected items from the list of holidays.
- **Edit:** Select a holiday item and then change the date.
- **Set Applied Timer:** Set the **On Timer** and **Off Timer** to not activate on public holidays.
  - Press ↵ to select the **On Timer** and **Off Timer** settings you do not want to activate.
  - The selected **On Timer** and **Off Timer** will not activate.

## Ticker

HOME 🏠 → **Ticker** → ENTER ↵

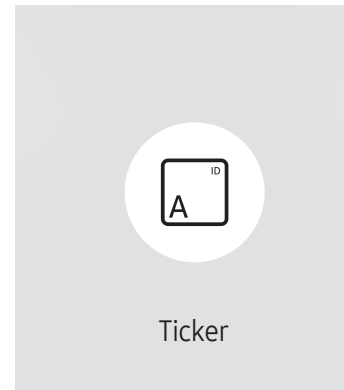

– The displayed image may differ depending on the model.

Input text while a video or image is displayed and display the text on the screen.

– You must set **Clock Set** before you can use this feature.

- **Off / On:** Set whether or not to use **Ticker**.
- **Message:** Enter a message to display on the screen.
- **Time:** Set the **Start Time** and **End Time** to display a **Message**.
- **Font options:** Specify the text font and colour for the message.
- **Position:** Select a position to display a **Message**.
- **Scroll:** Turn scroll effects of **Ticker** on or not. Specify the scroll **Direction** and **Speed** for the message.
- **Preview:** Preview your **Ticker** settings.

---

## URL Launcher

HOME  → URL Launcher → ENTER 

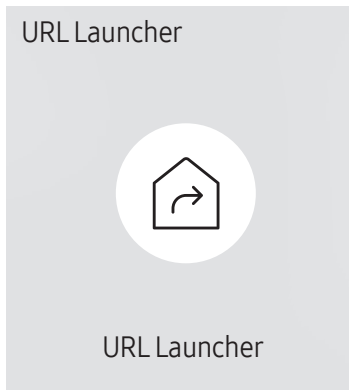

---

– The displayed image may differ depending on the model.

For details on how to use the **URL Launcher** feature, contact the dealer the product was purchased from.

- To use the **URL Launcher** feature, set **Play via** to **URL Launcher** in **System**.  
(MENU  → **System** → **Play via** → **URL Launcher**)

## URL Launcher Settings

HOME  → URL Launcher Settings → ENTER 

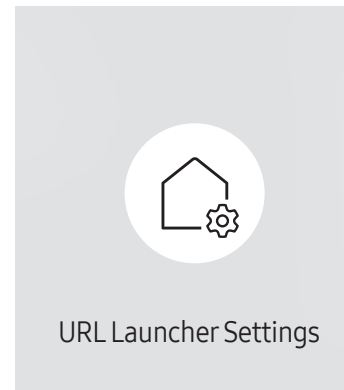

---

– The displayed image may differ depending on the model.

– For details on how to use the **URL Launcher** feature, contact the dealer the product was purchased from.

- **Install Web App**: Enter URL to install the web application.
- **Install from USB Device**: Install the web application from the USB storage device.
- **Uninstall**: Remove the installed web application.
- **Timeout Setting**: Set the timeout period for connecting to the URL.
- **Developer Mode**: Enable developer mode.

# Chapter 06

## Screen Adjustment

Configure the **Picture** settings (**Backlight**, **Colour Tone**, etc.).

The layout of the **Picture** menu options may vary depending on the product.

### Backlight / Brightness / Contrast / Sharpness

MENU  → **Picture** → ENTER 

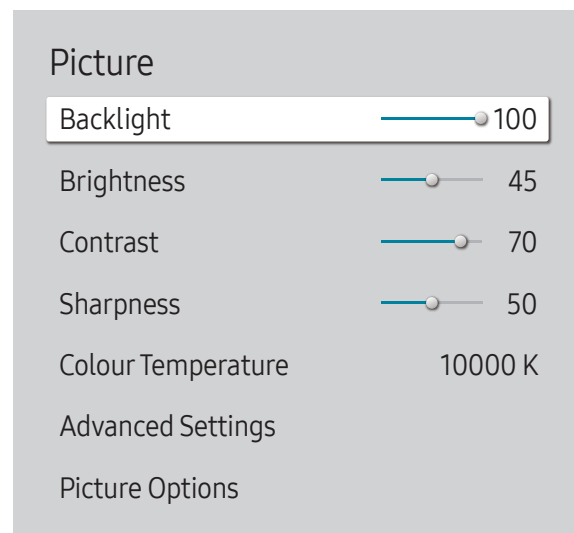

Your product has several options for adjusting picture quality.

- You can adjust and store settings for each external device you have connected to an input on the product.
- Lowering picture brightness reduces power consumption.

— The displayed image may differ depending on the model.

---

## Colour Temperature

MENU  → Picture → Colour Temperature → ENTER 



It sets colour temperature. The value and temperature increase simultaneously, so the ratio of blue colour rises.  
(Range: 2800K–16000K)

— Enabled when **Colour Tone** is set to **Off**.

---

– The displayed image may differ depending on the model.

# Advanced Settings

MENU  → Picture → Advanced Settings → ENTER 

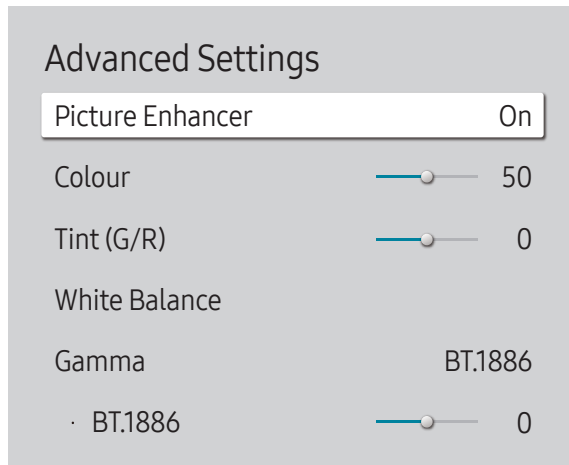

Configure advanced picture settings to create your preferred picture.

## Picture Enhancer

Displays enhanced colour and sharpness.

- Off / On

## Colour

Adjust the colour saturation levels. Colour saturation intensifies as the value nears 100. (Range: 0~100)

## Tint (G/R)

Adjust the ratio of green to red tint levels. Increasing values intensifies the saturation of red and green colours. (Range: 0~50)

– The displayed image may differ depending on the model.

---

## White Balance

Adjust the colour temperature of the picture so that white objects appear brighter.

### 2 Point

Adjust red, green, and blue luminosity levels in two sections for precise white balance optimisation.

- **R-Offset / G-Offset / B-Offset:** Adjust the proportion of each of red, green and blue colours in dark areas.
- **R-Gain / G-Gain / B-Gain:** Adjust the proportion of each of red, green and blue colours in bright areas.
- **Reset:** Restore the white balance settings to the default values.

### 20 Point Settings

Controls the white balance in 20 point interval by adjusting the red, green, and blue brightness.

#### 20 Point

Adjust red, green, and blue luminosity levels in twenty sections for precise white balance optimisation.

- **Off** (●) / **On** (●)
- **Interval:** Select interval to adjust.
- **Red:** Adjust the red level.
- **Green:** Adjust the green level.
- **Blue:** Adjust the blue level.
- **Reset:** Restore the current level's 20 point White Balance to the default values.

— Some external devices may not support this function.

## Gamma

Adjust the mid-range brightness of the picture.

- **HLG / ST.2084 / BT.1886 / S Curve**
- **Gamma** settings **HLG**, **ST.2084**, and **BT.1886** may change depending on the input video settings.

### HLG / ST.2084 / BT.1886 / S Curve

Adjust the **HLG**, **ST.2084**, **BT.1886**, **S Curve** levels of the picture.

## Contrast Enhancer

Automatically balance the contrast to prevent excessive differences between bright and dark areas.

- **Off / Low / Medium / High**

## Black Tone

Select the black level to adjust the screen depth.

- **Off / Dark / Darker / Darkest**

## Flesh Tone

Adjust the flesh tone colour by increasing or decreasing red levels.

## RGB Only Mode

Fine-tune the saturation and tint of the red, green, and blue colour channels.

- **Off / Red / Green / Blue**

## Colour Space Settings

Configure colour space settings to refine the spectrum of colours on your screen.

### Colour Space

Choose a colour space.

- **Auto / Native / Custom**

— To adjust **Colour**, **Red**, **Green**, **Blue** and **Reset**, set **Colour Space** to **Custom**.

## Input Signal Plus

Expands the input signal range for HDMI connections.

- **HDMI1 (Off (●) / On (●))**
- **HDMI2 (Off (●) / On (●))**

— When **Input Signal Plus** is set to **On**, up to the 4096 x 2160p @ 60 Hz resolution is supported.  
When **Input Signal Plus** is set to **Off**, up to the 1920 x 1080 @ 60 Hz resolution is supported.

— The screen may blink when **HDMI2 Input Signal Plus** is turned **On** or **Off** from the DP source.

## Supported Resolutions for UHD Input Signals

Check the supported resolution for UHD input signals.

- Resolution: 3840 x 2160p, 4096 x 2160p
- Even if the UHD signal is input, display outputs as a 1920 x 1080 @ 60 Hz resolution on the actual screen.

If **Input Signal Plus** is set to **Off**

Frame rate (fps)	Colour Depth / Chroma Sampling	RGB 4:4:4	YCbCr 4:4:4	YCbCr 4:2:2	YCbCr 4:2:0
50 / 60	8 bit	-	-	-	0

If **Input Signal Plus** is set to **On**

Frame rate (fps)	Colour Depth / Chroma Sampling	RGB 4:4:4	YCbCr 4:4:4	YCbCr 4:2:2	YCbCr 4:2:0
50 / 60	8 bit	0	0	0	0
	10 bit	-	-	0	0
	12 bit	-	-	0	0

## Motion Lighting

Reduces power consumption by reducing screen brightness when the picture on the screen is in motion.

- **Off / On**

# Picture Options

MENU  → Picture → Picture Options → ENTER 

Picture Options	
Colour Tone	Off
Digital Clean View	Off
HDMI Black Level	Auto
Film Mode	Off
Auto Motion Plus Settings	Auto
Local Dimming	High
Dynamic Peaking	On

– The displayed image may differ depending on the model.

## Colour Tone

Select the colour tone that best suits your viewing preferences.

- Off / Cool / Standard / Warm1 / Warm2 / Natural

– Settings can be adjusted and stored for each external device connected to an input on the product.

## Digital Clean View

Reduce picture noise to avoid distractions such as flickering.

- Auto / Off

## HDMI Black Level

Adjust the black level to optimise the HDMI picture brightness and contrast.

- Normal / Low / Auto

## Film Mode

Make frame transitions from older video sources smoother. This function is only available when the input signal is HDMI (1080i).

- Off / Auto1 / Auto2

## Auto Motion Plus Settings

Enhance picture sharpness to optimise for fast-moving images.



## Picture Options

Colour Tone	Off
Digital Clean View	Off
HDMI Black Level	Auto
Film Mode	Off
Auto Motion Plus Settings	Auto
Local Dimming	High
Dynamic Peaking	On

## Local Dimming

Adjust brightness levels of individual on-screen areas for optimum contrast.

- Off / Low / Standard / High

## Dynamic Peaking

Automatically adjust the backlight to provide the best possible screen contrast under the current conditions.

- Off / On

– The displayed image may differ depending on the model.

---

## Apply Picture Settings

MENU  → Picture → Apply Picture Settings → ENTER 

Apply the picture settings to all external devices connected to the device or to the current source only.

- All Sources / Current Source

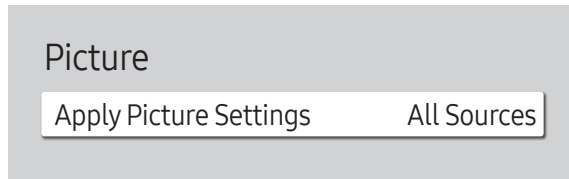

---

– The displayed image may differ depending on the model.

# Picture Size Settings

MENU  → Picture → Picture Size Settings → ENTER 

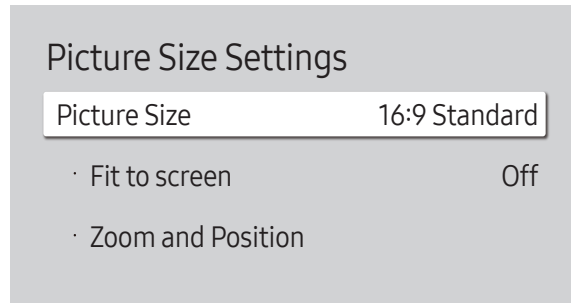

– The displayed image may differ depending on the model.

Choose size and aspect ratio picture displayed on screen.

– The **Picture Size Settings** menu is only enabled in landscape mode.

## Picture Size

Different screen adjustment options are displayed depending on the current input source.

- **16:9 Standard**: Sets the picture to **16:9 Standard** wide mode.
- **Custom**: Changes the resolution to suit the user's preferences.
- **4:3**: Sets the picture to basic (**4:3**) mode.

– Do not set your product to **4:3** format for a long time.

The borders displayed on the left and right, or top and bottom of the screen may cause image retention (screen burn) which is not covered by the warranty.

## Fit to screen

Adjusts the picture position. When selected, the full programme image will be displayed. No part of the image will be cut off.

- **Off / On / Auto**

## Zoom and Position

Adjusts the picture zoom and position. This function is available only if **Picture Size** is set to **Custom**.

– If you want to reset the picture to its original position, select **Reset** in the **Zoom and Position** screen. The picture will be set to its default position.

---

## Reset Picture

Restore all picture settings to the factory default.

MENU  → Picture → Reset Picture → ENTER 

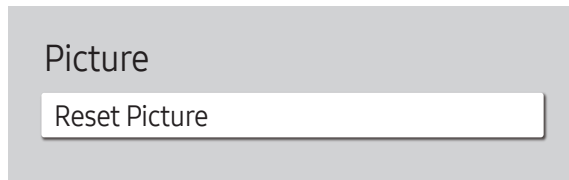



---

– The displayed image may differ depending on the model.

# Chapter 07

## OnScreen Display

### Display Orientation

MENU  → OnScreen Display → Display Orientation → ENTER 

Display Orientation	
Onscreen Menu Orientation	Landscape
Source Content Orientation	Landscape
Aspect Ratio	Full Screen

– The displayed image may differ depending on the model.

### Onscreen Menu Orientation

Select whether the onscreen menu should be displayed in landscape or portrait orientation.

- **Landscape:** Display the menu in landscape mode.
- **Portrait:** Display the menu in portrait mode on the right side of the product screen.

### Source Content Orientation

Rotate the product screen orientation.

– This feature is not available for input source resolutions higher than 7680 x 4320.

- **Landscape:** Display the screen in landscape mode.
- **Portrait:** Display the screen in portrait mode.



### Aspect Ratio

Set the rotated screen to be either full screen or original.

- **Full Screen:** Display the rotated screen in full screen.
- **Original ratio:** Display the rotated screen in the original aspect ratio.

– Available only when **Source Content Orientation** is set to **Portrait**.

# Screen Protection

MENU  → OnScreen Display → Screen Protection → ENTER 

## Auto Protection Time

If the screen displays a still image for a certain period of time you define, the product activates the screen saver to prevent the formation of burnt in ghost images on the screen.

- Off / 2 hours / 4 hours / 6 hours / 8 hours / 10 hours

## Screen Burn Protection

To reduce the possibility of screen burn, this unit is equipped with **Screen Burn Protection** (screen burn prevention technology).

**Screen Burn Protection** moves the picture slightly on the screen.

## Timer

You can set the timer for **Screen Burn Protection**.

The **Screen Burn Protection** feature stops automatically after a specified period of time.

### Timer

#### Off

**Repeat:** Display the image retention-preventive pattern set in **Mode** at specified time intervals(Period).

**Interval:** Display the image retention-preventive pattern set in **Mode** for a specified period of time (from **Start Time** to **End Time**).

— **Mode, Period, Time, Start Time** and **End Time** are enabled only when **Timer** is set to **Repeat** or **Interval**.



- **Mode:** Select a screen protective pattern to display.
  - **Pixel:** Pixels on the screen alternate black continuously.
  - **Rolling bar:** A vertical bar moves left to right.
  - **Fading screen:** The entire screen becomes brighter, then darker.
- The **Rolling bar** and **Fading screen** patterns appear only once regardless of the specified repeat period or time.
- **Period:** Specify the time interval to activate the **Screen Burn Protection** function.
  - The option is enabled when **Repeat** is selected for **Timer**.
- **Time:** Specify the duration to keep the **Screen Burn Protection** function on.
  - Enabled when **Timer** is set to **Repeat** and **Mode** is set to **Pixel**.
- **Start Time:** Set the start time to activate the screen protection function.
  - The option is enabled when **Interval** is selected for **Timer**.
- **End Time:** Set the end time to deactivate the screen protection function.
  - The option is enabled when **Interval** is selected for **Timer**.

## Immediate display

Select the screen saver you want to display immediately.

- Off / Pixel / Rolling bar / Fading screen

# Message Display

MENU  → OnScreen Display → Message Display → ENTER 

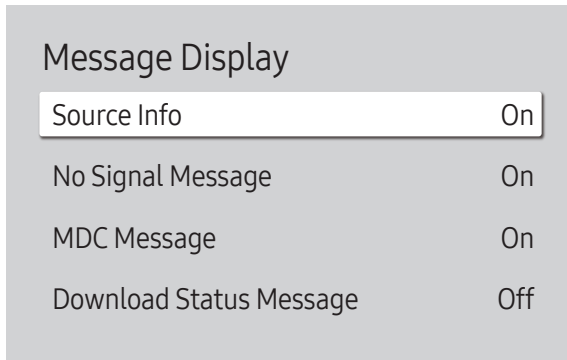

Message Display	
Source Info	On
No Signal Message	On
MDC Message	On
Download Status Message	Off

– The displayed image may differ depending on the model.

## Source Info

Select whether to display the source OSD when the input source changes.

- Off / On

## No Signal Message

Select whether to display the no-signal OSD when no signal is detected.

The message **No Cable Connected** will appear if no source device is connected.

- Off / On

## MDC Message

Select whether to display the MDC OSD when the product is controlled by the MDC.

- Off / On

## Download Status Message

Select to display the status when downloading content from a server or other device.

- Off / On

---

## Language

MENU  → OnScreen Display → Language → ENTER 

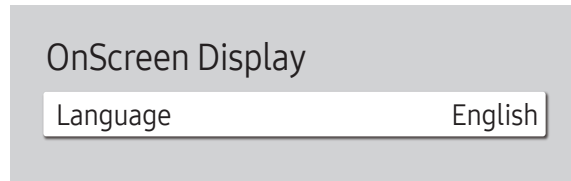

---

– The displayed image may differ depending on the model.

Set the menu language.

- A change to the language setting will only be applied to the onscreen menu display. It will not be applied to other functions on your PC.

## Reset OnScreen Display

MENU  → OnScreen Display → Reset OnScreen Display → ENTER 

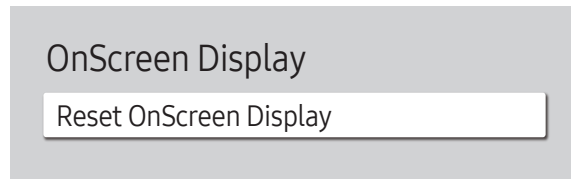

---

– The displayed image may differ depending on the model.

This option returns the current settings under **OnScreen Display** to the default factory settings.



# Chapter 08

## Network

### Network Status

MENU  → Network → Network Status → ENTER 

You can check the current network and Internet status.

### Open Network Settings

MENU  → Network → Open Network Settings → ENTER 

Configure network settings to connect to an available network.

## Network Settings (Wired)

### Connecting to a Wired Network

There are three ways to attach your product to your LAN using cable.

- You can attach your product to your LAN by connecting the LAN port on the back of your product to an external modem using a LAN cable. See the diagram below.

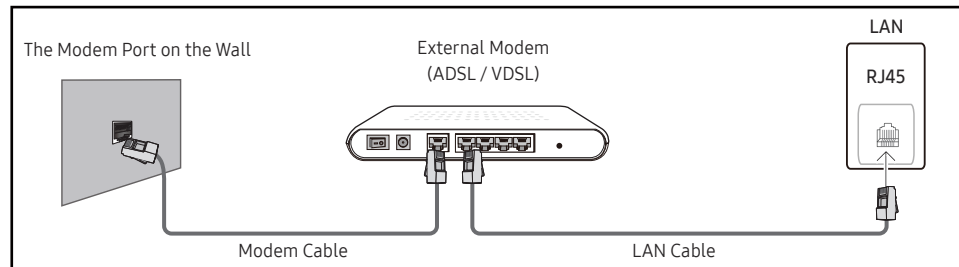

- You can attach your product to your LAN by connecting the LAN port on the back of your product to an IP Sharer which is connected to an external modem. Use LAN cable for the connection. See the diagram below.

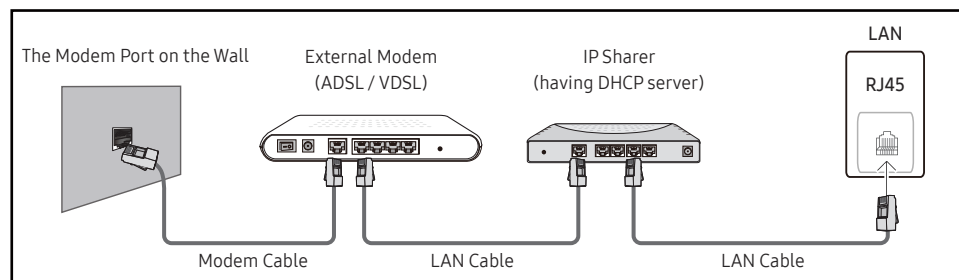

- Depending on how your network is configured, you may be able to attach your product to your LAN by connecting the LAN port on the back of your product directly to a network wall outlet using a LAN cable. See the diagram below. Note that the wall outlet is attached to a modem or router elsewhere in your house.

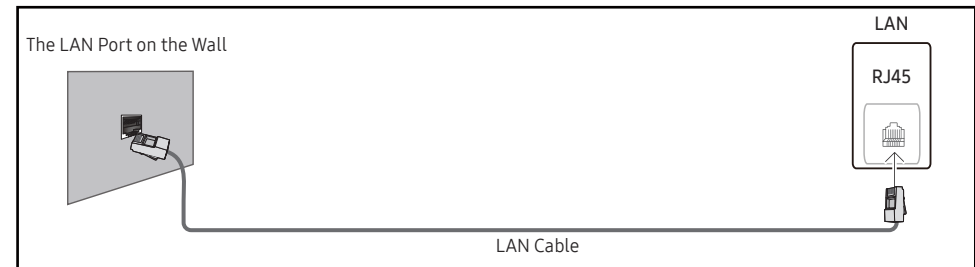

If you have a Dynamic Network, you should use an ADSL modem or router that supports the Dynamic Host Configuration Protocol (DHCP). Modems and routers that support DHCP automatically provide the **IP Address**, **Subnet Mask**, **Gateway**, and DNS values your product needs to access the Internet so you do not have to enter them manually. Most home networks are Dynamic Networks.

Some networks require a Static IP address. If your network requires a Static IP address, you must enter the **IP Address**, **Subnet Mask**, **Gateway**, and DNS values manually on your product **IP Settings** when you set up the network connection. To get the **IP Address**, **Subnet Mask**, **Gateway**, and DNS values, contact your Internet Service Provider (ISP).

If you have a Windows computer, you can also get these values through your computer.

- You can use ADSL modems that support DHCP if your network requires a Static IP address.
- ADSL modems that support DHCP also let you use Static IP addresses.

---

Set the network connection to use Internet services such as perform software upgrades.

## Automatic Open Network Settings (Wired)

Connect to the network using a LAN cable.

Make sure a LAN cable is connected first.

### How to set up automatically

1 Select **Open Network Settings**. The **Open Network Settings** session starts.

2 The network test screen appears and verifies the network connection.

When the connection has been verified, the **“Success! Your device is connected to the Internet. If you have any problems using online services, please contact your Internet service provider.”** message appears.

— If the connection process fails, check the LAN port connection.

— If the automatic process cannot find the network connection values or if you want to set the connection manually, go to the next section(Manual Open Network Settings (Wired)).

---

## Manual Open Network Settings (Wired)

Offices may use static IP addresses.

If this is the case, ask the network administrator for the **IP Address**, **Subnet Mask**, **Gateway** and DNS server address. Enter these values manually.



### Getting the Network Connection Values

To view the Network connection values on most Windows computers, follow these steps.

- 1 Right click the Network icon on the bottom right of the screen.
- 2 In the pop-up menu that appears, click Status.
- 3 On the dialog that appears, click the **Support** tab.
- 4 On the **Support** Tab, click the **Details** button. The Network connection values are displayed.

— The path to the settings depends on the installed OS.

### How to set up manually

- 1 Select **Open Network Settings**. The **Open Network Settings** session starts.
- 2 The network test screen appears and the verification process starts. Press Cancel. The verification process stops.
- 3 Select **IP Settings** on network connection screen. The **IP Settings** screen appears.
- 4 Select the field at the top, press , and then set **IP setting** to **Enter manually**. Repeat the entry process for each field in the **IP Address**.
  - Setting **IP setting** to **Enter manually** automatically changes **DNS setting** to **Enter manually**.
- 5 When done, select **OK** at the bottom of the page, and then press . The network test screen appears and the verification process starts.
- 6 When the connection has been verified, the “**Success! Your device is connected to the Internet. If you have any problems using online services, please contact your Internet service provider.**” message appears.

---

## Server Network Settings

MENU  → Network → Server Network Settings → ENTER 

### Connect to server

Connect to MagicInfo server.

- **Server Address / TLS / Port**
- If you do use the **TLS** option, the server is configured to use https and data transfer is encrypted. (Port number: 7002)
- If you don't use the **TLS** option, enter the server IP address and port number. Use 7001 as the port number. (If you are unable to connect to the server using port number 7001, check with your server administrator to find the correct port number and then change the port number.)
- Enter the server IP address and port number. Use 7001 as the port number. (If unable to connect to the server using port number 7001, check with your server administrator to find the correct port number and then change the port number.)
- For the MagicInfo Server user guide, visit the following website: <http://displaysolutions.samsung.com> → Support → Resources → MagicInfo Web Manual.

### MagicInfo Mode

Select the appropriate **MagicInfo Mode** depending on the environment where you are using the product.

- **Lite / Premium**
- Supported content types may be limited while **MagicInfo Mode** is set to **Lite**.

### Server Access

Allow or deny access to MagicInfo server.

- **Allow / Deny**

### FTP Mode

Specify the FTP operating mode.

- **Active / Passive**

### Proxy server

Set up your proxy server connection and related functions.

**Off / On**

- **Address / Port / ID / Password**
- **Address / Port / ID** and **Password** are enabled only when **Proxy server** is set to **On**.

## Device Name

MENU  → Network → Device Name → ENTER 

Select or enter a device name.

This name can be shown on network device over the network.

- **[Signage] Display1 ~ 6 / User Input**

# Chapter 09

## System

### Accessibility

MENU  → System → Accessibility → ENTER 

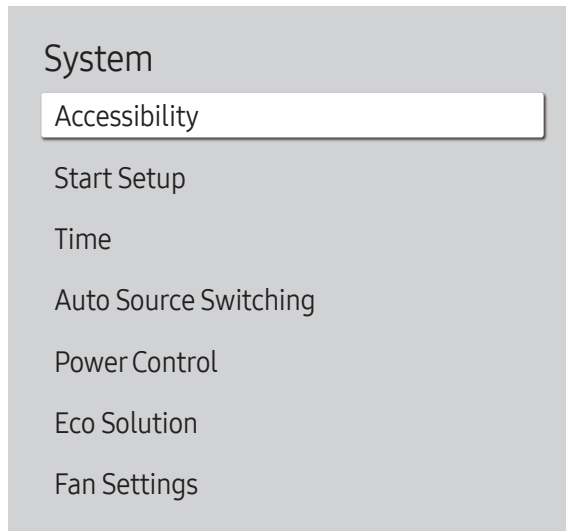

– The displayed image may differ depending on the model.

### Voice Guide Settings

#### Voice Guide

Switch **Voice Guide** on or off. The language used for **Voice Guide** will be the same as the current menu language.

- Off (●) / On (●)

– **Volume**, **Speed** and **Pitch** are enabled only when **Voice Guide** is set to **On**.

#### Volume

Set the volume level for the **Voice Guide**.

- Loud / Medium / Soft

#### Speed

Set the speed of the **Voice Guide**.

- Very Fast / Fast / Normal / Slow / Very Slow

#### Pitch

Tune the pitch of the **Voice Guide**.

- High / Medium / Low

## Accessibility

Voice Guide Settings Off

High Contrast

Enlarge

## High Contrast

Set the background and font to high-contrast colours in Menu. Menu transparencies become opaque when the option is selected.

- Off (●) / On (●)

## Enlarge

Enlarge the size of the Menu area.

- Off (●) / On (●)

– The displayed image may differ depending on the model.

## Start Setup

MENU  → System → Start Setup → ENTER 

## System



Start Setup

Go through the initial setup steps like you did the first time you used this product.

- Enter your 4 digit PIN number. The default PIN number is "0-0-0-0".  
If you want to change the PIN number, use the **Change PIN** function.
- Change the PIN to keep your device secure.

– The displayed image may differ depending on the model.

# Time

MENU  → System → Time → ENTER 

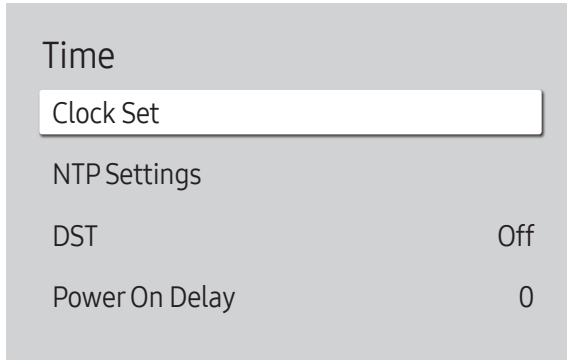

– The displayed image may differ depending on the model.

You can configure **Clock Set** or **DST**. Configure various time-related settings.

## Clock Set

Select **Clock Set**. Select **Date** or **Time**, and then press .

Use the number buttons to enter numbers or press the up and down arrow buttons. Use the left and right arrow buttons to move from one entry field to the next. Press  when done.

– You can set the **Date** and **Time** directly by pressing the number buttons on the remote control.

## NTP Settings

Set up the server URL and time zone to use the network time.

## DST

Switches the DST (Daylight Saving Time) function on or off.

**Off / On**

- **Start Date**: Set the start date of Daylight Saving Time.
- **End Date**: Set the end date of Daylight Saving Time.
- **Time Offset**: Select the correct time offset for your timezone.

– **Start Date**, **End Date** and **Time Offset** are enabled only when **DST** is set to **On**.

## Power On Delay

When connecting multiple products, adjust the power-on time for each product to prevent power overload (within the range 0–50 seconds).



## Auto Source Switching

MENU  → System → Auto Source Switching → ENTER 

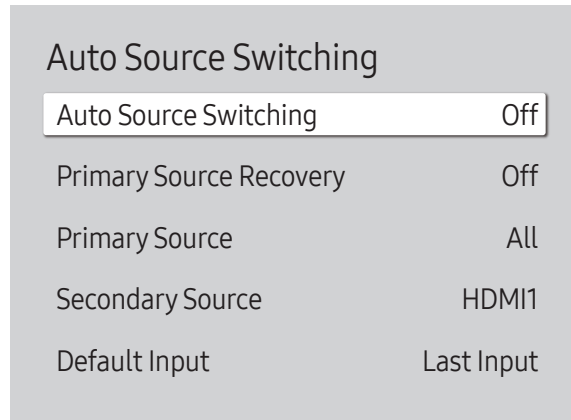

Auto Source Switching	
Auto Source Switching	Off
Primary Source Recovery	Off
Primary Source	All
Secondary Source	HDMI1
Default Input	Last Input

– The displayed image may differ depending on the model.

## Auto Source Switching

Switch to preset source or another source when the main source device gets disconnected.

### Primary Source Recovery

Select whether to restore the selected primary input source when a primary input source is activated.

– The **Primary Source Recovery** function is disabled if **Primary Source** is set to **All**.

### Primary Source

Select a primary source to switch to when no signals are received from the current input.

### Secondary Source

Select a secondary source to switch to when no signals are received from the current input.

– The **Secondary Source** function is disabled if **Primary Source** is set to **All**.

### Default Input

Select the default input to switch to when the new input is disconnected. The **Last Input** option only includes external inputs connected via cables.

– **Auto Source Switching** must be set to **New Input** to enable the **Default Input** option.

# Power Control

MENU  → System → Power Control → ENTER 

Power Control	
Auto Power On	Off
Max. Power Saving	On
Standby Control	On
Remote Configuration	Off
Power Button	Power on only

– The displayed image may differ depending on the model.

## Auto Power On

This feature automatically turns on the product as soon as it is plugged in. Pressing the power button is not needed.

- Off / On

## Max. Power Saving

Conserve power by turning off PC monitor when PC is not used for certain time.

- Off / On

## Standby Control

When no signal is detected, it determines whether or not to enter sleep mode.

- Auto  
The display stays off to save energy until working signals are detected even if there is an external device connected.  
The message **No Cable Connected** will appear if no source device is connected.
- Off  
The message **No Signal** will appear if no input signals are detected.
  - If the message, "**No Signal**" appears even though a source device is connected, check the cable connections and the settings of your source device.
  - If **No Signal Message** is set to **Off**, the **No Signal** message does not appear.  
In this case, set **No Signal Message** to **On**.
- On  
The display turns off to save energy if no input signals are detected.

## Power Control

Auto Power On	Off
Max. Power Saving	On
Standby Control	On
Remote Configuration	Off
Power Button	Power on only



## Remote Configuration

This feature keeps the network power on when the product turns off.

- **Off / On**

## Power Button

The power button on the remote control  can be set to turn on the power or turn on or off the power.

- **Power on only:** Set the power button on the remote control  only to turn on the power.
- **Power on and off:** Set the power button on the remote control  to turn on or off the power.

– The displayed image may differ depending on the model.

## Eco Solution

MENU  → System → Eco Solution → ENTER 

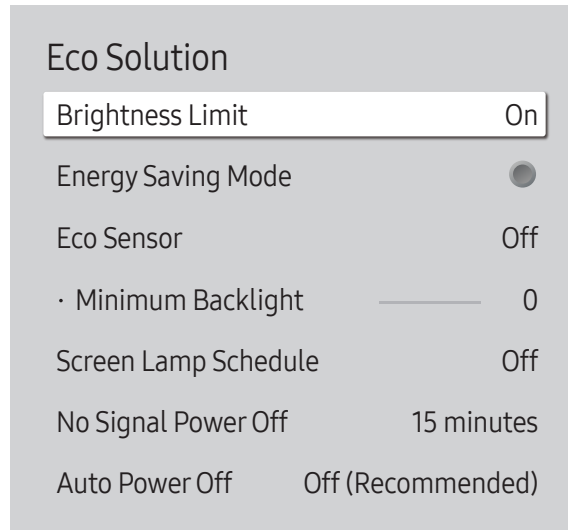

– The displayed image may differ depending on the model.

## Brightness Limit

Turn the **Brightness Limit** on or off. If you select **On**, the display won't have the maximum brightness, but you will save energy.

- Off / On

## Energy Saving Mode

Reduce the power consumption by adjusting the screen brightness.

- Off (●) / On (●)

## Eco Sensor

Automatically adjust the picture brightness based on the ambient light level.

- Off / On

– If the screen contrast is not sufficient, set the **Eco Sensor** to **Off**. If the **Eco Sensor** is **Off**, it may not comply with energy standards.

## Minimum Backlight

Set the minimum brightness for the signage screen. This function only works if its value is lower than the value set in the **Picture** menu's **Backlight** setting.

- If **Eco Sensor** is **On**, the display brightness may change (become slightly darker or brighter) depending on the surrounding light intensity.
- Available only when **Eco Sensor** is set to **On**.

## Eco Solution

Brightness Limit	On
Energy Saving Mode	Off
Eco Sensor	Off
· Minimum Backlight	0
Screen Lamp Schedule	Off
No Signal Power Off	15 minutes
Auto Power Off	Off (Recommended)

– The displayed image may differ depending on the model.

## Screen Lamp Schedule

### Screen Lamp Schedule

Enable or disable the lamp schedule.

- Off / On

### Schedule 1, Schedule 2

#### Time

The panel brightness will change to the brightness set in **Lamp** at a specified time.

#### Lamp

Adjust the panel brightness. A value closer to 100 makes the panel brighter.

- 0 ~ 100

## No Signal Power Off

Save power by turning the product off when no signal is received from any source.

- This function does not operate if the display is in the standby mode.
- The product will automatically power off at a specified time. The time can be changed as required.

## Auto Power Off

Choose how long the display will wait before turning off after no user interaction is detected.

# Fan Settings

MENU  → System → Fan Settings → ENTER 

Fan Settings	
Fan Control	Auto
Fan Speed Setting	100
Outdoor Mode	Off

– The displayed image may differ depending on the model.

It sets items related to the speed and temperature of the fan in each set.

## Fan Control

Selects auto or manual for the fan speed settings.

- Auto / Manual

## Fan Speed Setting

Sets the fan speed within a range of 1 and 100.

– Enabled when **Fan Control** is set to **Manual**.

## Outdoor Mode

To use the product at a low temperature below 0 °C, make sure to set **Outdoor Mode** to "On".

This feature keeps the internal temperature of the product steady so that the product can start properly when it is powered on.



- Off / On

– Do not disconnect the power cable when this feature is set to "On".

– The product consumes more power when it is turned off if this feature is set to "On" rather than to "Off".

---

## Play via

MENU  → System → Play via → ENTER 

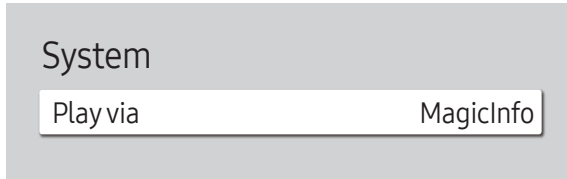

---

– The displayed image may differ depending on the model.

Select the appropriate **Play via** mode depending on the environment where you are using the product.  
The home screen may be different depending on the setting.

- **MagicInfo / URL Launcher**

## Change PIN

MENU  → System → Change PIN → ENTER 



---

– The displayed image may differ depending on the model.



Change your 4-digit Personal Identification Number (PIN).

Choose any 4 digits for your PIN and enter it in **Enter a new PIN..** Reenter the same 4 digits in **Enter the PIN again..**

The product has memorised your new PIN.

- The default PIN number is "0-0-0-0".
- Change the PIN to keep your device secure.

# Security

MENU  → System → Security → ENTER 

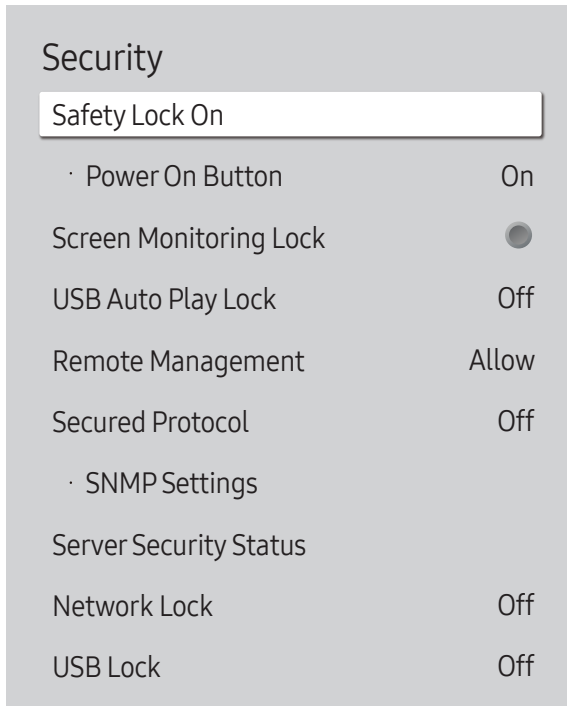

## Safety Lock On

- Enter your 4 digit PIN number. The default PIN number is "0-0-0-0".  
If you want to change the PIN number, use the **Change PIN** function.
- Change the PIN to keep your device secure.

Turn **Safety Lock On** on or off. **Safety Lock On** restricts the actions that can be carried out by the remote control. The correct PIN must be entered to turn **Safety Lock On** off.

### Power On Button

Turn on this feature to enable the remote control's Power button to turn on the product while **Safety Lock On** is enabled.

- **Off / On**

## Screen Monitoring Lock

Blocks screen images from being monitored by **MagicInfo** Server.



– The displayed image may differ depending on the model.



---

## USB Auto Play Lock

Select whether to automatically play **MagicInfo** content saved on a connected USB device.

- Your content should be a **Published Content**  that is authored by using **MagicInfo Premium** application and published to the USB device you are using. The **MagicInfo Premium** application programme is available on the website. (<http://displaysolutions.samsung.com>)
- When published to a USB device, your **Published Content**  is saved to **Contents** and **Schedules** folders in the root folder of the connected USB device.
  - **Off**  
Play **MagicInfo** content saved on the USB device automatically.
  - **On**  
Do not play **MagicInfo** content saved on the USB device automatically.
- Connecting a USB device containing **MagicInfo** content displays "**USB Auto Play Lock : On**" for five seconds.

## Remote Management

You can **Allow** or **Deny** external commands to access your product via a network.

- **Deny / Allow**

## Secured Protocol

Secure the protocol between this device and other devices.

- **Off / On**

### SNMP Settings

Set up your ID and password for the SNMP connection.

## Server Security Status

You can check the security status of this device if it is managed remotely on the server.

- This function is enabled when connected to **MagicInfo** server.

## Network Lock

Block external network access. You can register networks on the server to allow access.

- **Off / On**
  - Make sure that the product is connected to the network.

## USB Lock

Block connection to external USB ports.

- **Off / On**

# General

MENU  → System → General → ENTER 

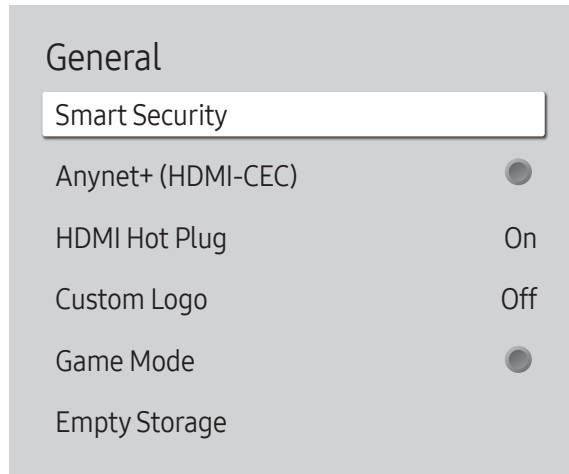

– The displayed image may differ depending on the model.

## Smart Security

The security provided to protect your display device and connected storage devices against viruses includes.

### Scan

Inspect your display device and connected storage devices to check for viruses.

### Isolated List

This is the list of items that have been Isolated for containing viruses.

## Anynet+ (HDMI-CEC)

Anynet+ is a function that enables you to control all connected Samsung devices that support Anynet+ with your Samsung product remote control. The Anynet+ system can be used only with Samsung devices that have the Anynet+ feature. To be sure your Samsung device has this feature, check if there is an Anynet+ logo on it.

- Off (●) / On (●)

- You can only control **Anynet+** devices using the product remote control, not the buttons on the product.
- The product remote control may not work under certain conditions. If this occurs, reselect the **Anynet+** device.
- **Anynet+** works when the AV device supporting **Anynet+** is in the standby or on status.
- **Anynet+** supports up to 12 AV devices in total. Note that you can connect up to 3 devices of the same type.
- Some equipment may not be able to switch sources. In this case, turn off **Anynet+ (HDMI-CEC)**.

---

## Troubleshooting for Anynet+

Problem	Possible Solution
Anynet+ does not work.	<ul style="list-style-type: none"><li>• Check if the device is an Anynet+ device. The Anynet+ system supports Anynet+ devices only.</li><li>• Check if the Anynet+ device power cord is properly connected.</li><li>• Check the Anynet+ device's Video/Audio/HDMI cable connections.</li><li>• Check whether <b>Anynet+ (HDMI-CEC)</b> is set to <b>On</b> in the <b>System</b> menu.</li><li>• Check whether the remote control is Anynet+ compatible.</li><li>• Anynet+ doesn't work in certain situations. (initial setup)</li><li>• If you have removed and then reconnected the HDMI cable, please make sure to search devices again or turn your product off and on again.</li><li>• Check if the Anynet+ function of the Anynet device is set on.</li></ul>
I want to start Anynet+.	<ul style="list-style-type: none"><li>• Check if the Anynet+ device is properly connected to the product and check if the <b>Anynet+ (HDMI-CEC)</b> is set to <b>On</b> in the <b>System</b> menu.</li></ul>
I want to exit Anynet+.	<ul style="list-style-type: none"><li>• Press the <b>SOURCE</b> button on the product remote control and select a non- Anynet+ device.</li></ul>
The message " <b>Disconnecting Anynet+ device ...</b> " appears on the screen.	<ul style="list-style-type: none"><li>• You cannot use the remote control when you are configuring Anynet+ or switching to a view mode.</li><li>• Use the remote control after the product has completed Anynet+ configuration or has finished switching to Anynet+.</li></ul>
The Anynet+ device does not play.	<ul style="list-style-type: none"><li>• You cannot use the play function when initial setup is in progress.</li></ul>
The connected device is not displayed.	<ul style="list-style-type: none"><li>• Check whether or not the device supports Anynet+ functions.</li><li>• Check whether or not the HDMI cable is properly connected.</li><li>• Check whether <b>Anynet+ (HDMI-CEC)</b> is set to <b>On</b> in the <b>System</b> menu.</li><li>• Search Anynet+ devices again.</li><li>• Anynet+ requires an HDMI connection. Make sure the device is connected to your product with an HDMI cable.</li><li>• Some HDMI cables may not support Anynet+ functions.</li><li>• If the connection is terminated because there has been a power failure or the HDMI cable has been disconnected, please repeat the device scan.</li></ul>

## General

Smart Security

Anynet+ (HDMI-CEC)



HDMI Hot Plug

On

Custom Logo

Off

Game Mode



Empty Storage

## HDMI Hot Plug

This feature is used to activate the time delay to turn on a DVI/HDMI source device.

- Off / On

## Custom Logo

You can download, select, and set the display time of a custom logo that appears when the product turns on.

- **Custom Logo**
  - You can select a custom logo (image/video) or turn off the custom logo display.
  - You must download the custom logo from an external USB device to set the custom logo.
- **Logo Display Time**
  - If the type of custom logo is **Image**, you can set the **Logo Display Time**.
- **Download Logo File**
  - You can download a custom logo into the product from an external USB device.
  - The file name of the custom logo you want to download must be saved as “samsung” in all small letters.
  - When there are multiple numbers of external USB connections, the product will attempt to download the custom logo from the last device that has been connected to the product.

### Custom logo file restrictions

- Images up to 50 MB in size can be used.
  - Supported image file: samsung\_image.\*
  - Supported file extensions: jpg, jpeg, bmp, png
- Videos up to 150 MB in size can be used. The recommendation is under 20 seconds in length.
  - Supported video file: samsung\_video.\*
  - Supported file extensions: avi, mpg, mpeg, mp4, ts, wmv, asf

– The displayed image may differ depending on the model.

## General

Smart Security

Anynet+ (HDMI-CEC)



HDMI Hot Plug

On

Custom Logo

Off

Game Mode



Empty Storage

## Game Mode

When connecting to a game console such as PlayStation™ or Xbox™, you can enjoy a more realistic gaming experience by selecting game mode.

- Off (●) / On (●)

— If you connect other external devices while **Game Mode** is on, the screen may not be in good condition.

## Empty Storage

Delete files to make space for new content. Recently played files will not be deleted.

— The displayed image may differ depending on the model.

## Reset System

MENU  → System → Reset System → ENTER 

## System

Reset System

Reset all system settings to default.

— The displayed image may differ depending on the model.

# Chapter 10

## Support

### Software Update

MENU  → **Support** → **Software Update** → ENTER 

The **Software Update** menu lets you upgrade your product software to the latest version.

- Be careful not to turn off the power until the upgrade is complete. The product will turn off and on automatically after completing the software upgrade.
- When you upgrade software, all video and audio settings you have made will return to their default settings. We advise you to write down your settings so that you can easily reset them after the upgrade.

### Update Now

Update the software to the latest version.

- **Current version**: This is the software version already installed in the product.



### Contact Samsung

MENU  → **Support** → **Contact Samsung** → ENTER 

You can view the address of the Samsung website, the call centre phone number, your product's model number, software version, Open Source Licence and other information.

- Go to **Contact Samsung** and find the product **Model Code** and **Software Version**.

### Reset All

MENU  → **Support** → **Reset All** → ENTER 

This option returns all the current settings for a display to the default factory settings.

# Chapter 11

## Troubleshooting Guide

- 
- Before calling Samsung Customer Service Centre, test your product as follows. If the problem persists, contact Samsung Customer Service Centre.

- 
- If the screen remains blank, check the PC system, video controller and cable.

## Requirements Before Contacting Samsung Customer Service Centre

### Testing the Product

Check if your product is operating normally by using the product test function.

If the screen remains blank while the power LED blinks even when the product is correctly connected to a PC, perform product testing.

- 1 Power off both the PC and product.
- 2 Disconnect all the cables from the product.
- 3 Power on the product.
- 4 If **No Signal** is displayed, the product is operating normally.

### Checking the Resolution and Frequency

**Not Optimum Mode** will briefly be displayed if a mode that exceeds a supported resolution is selected (refer to Supported Resolutions).

---

## Check the followings.

### Installation issue (PC mode)

---

The screen keeps switching on and off.

Check the cable connection between the product and PC, and ensure the connection is secure.

---

Blank spaces are found on all four sides of the screen when an HDMI or HDMI-DVI cable is connected to the product and PC.

The blank spaces found on the screen have nothing to do with the product.

---

Blank spaces on the screen are caused by the PC or graphics card. To resolve the problem, adjust the screen size in the HDMI or DVI settings for the graphics card.

---

If the graphics card settings menu does not have an option to adjust the screen size, update the graphics card driver to the latest version.

(Please contact the graphics card or computer manufacturer for further details about how to adjust the screen settings.)

---

### Screen issue

---

The power LED is off. The screen will not switch on.

Make sure that the power cord is connected.

---

**No Signal** is displayed on the screen.

Check that the product is connected correctly with a cable.

---

Check that the device connected to the product is powered on.

---

Depending on the type of external device, the screen may not display properly. In this case, connect it with the **HDMI Hot Plug** function turned **On**.



---

## Screen issue

<b>Not Optimum Mode</b> is displayed.	<p>This message is displayed when a signal from the graphics card exceeds the product's maximum resolution and frequency.</p> <p>Refer to the Standard Signal Mode Table and set the maximum resolution and frequency according to the product specifications.</p>
The images on the screen look distorted.	<p>Check the cable connection to the product.</p>
The screen is not clear. The screen is blurry.	<p>Remove any accessories (video extension cable, etc) and try again.</p> <p>Set the resolution and frequency to the recommended level.</p>
The screen appears unstable and shaky.	<p>Check that the resolution and frequency of the PC and graphics card are set within a range compatible with the product. Then, change the screen settings if required by referring to the Additional Information on the product menu and the Standard Signal Mode Table.</p>
There are shadows or ghost images left on the screen.	
The screen is too bright. The screen is too dark.	<p>Adjust <b>Brightness</b> and <b>Contrast</b>.</p>
Screen colour is inconsistent.	<p>Go to <b>Picture</b> and adjust the <b>Colour Space</b> settings.</p>
White does not really look white.	<p>Go to <b>Picture</b> and adjust the <b>White Balance</b> settings.</p>
There is no image on the screen and the power LED blinks every 0.5 to 1 second.	<p>The product is in power-saving mode.</p> <p>Press any key on the keyboard or move the mouse to return to the previous screen.</p>
The product will turn off automatically.	<p>Go to <b>System</b> and make sure <b>Sleep Timer</b> is set to <b>Off</b>.</p> <p>If a PC is connected to the product, check the power status of the PC.</p> <p>Make sure the power cable is connected properly to the product and power outlet.</p> <p>If the signal from a connected device is not detected, the product automatically turns off after 10 to 15 minutes.</p>

---

## Screen issue

Picture quality of the product is different from the dealer shop where it was purchased.	Use an HDMI cable to obtain high-definition (HD) picture quality.
The screen display does not look normal.	Encoded video content may cause the display to appear corrupted in scenes featuring fast moving objects such as in a sports event or action video.
	Low signal level or low picture quality may cause the display to appear corrupted. This does not mean the product is defective.
	A cell phone within a distance of one-meter radius may cause static on analogue and digital products.
The brightness and colour do not look normal.	Go to <b>Picture</b> and adjust the screen settings such as <b>Picture Mode</b> , <b>Colour</b> , <b>Brightness</b> and <b>Sharpness</b> .
	Go to <b>System</b> and adjust the <b>Energy Saving Mode</b> settings.
	Reset the screen settings to the default settings.
Lines (red, green or blue) are displayed on the screen.	These lines are displayed when there is a defect in DATA SOURCE DRIVER IC on the monitor. Contact a Samsung Service Centre to resolve the issue.
The display looks unstable and then freezes.	The screen may freeze when a resolution other than the recommended resolution is used or if the signal is not stable. To resolve the issue, change the PC resolution to the recommended resolution.
The screen cannot be displayed in full screen.	A scaled SD (4:3) content file can cause black bars on both sides of an HD channel screen.
	A video with an aspect ratio different from the product can cause black bars at the top and bottom of the screen.
	Change the screen size setting to full screen on the product or source device.

---

## Remote control issue

The remote control does not work.

Make sure that the batteries are correctly in place (+/-).

Check if the batteries are flat.

Check for power failure.

Make sure that the power cord is connected.

Check for any special lighting or neon signs switched on in the vicinity.

---

## Source device issue

A beeping sound is heard when my PC is booting.

If a beeping sound is heard when your PC is booting, have your PC serviced.

---

## Other issue

The product smells like plastic.

The plastic smell is normal and disappears over time.

The monitor appears tilted.

Remove and then attach the stand again to the product.

Audio or video cuts out intermittently.

Check the cable connection and connect it again if required.

Using a very hard or thick cable may corrupt audio and video files.

Make sure cables are flexible enough to ensure durability. When mounting the product onto a wall, it is recommended to use right-angle cables.

Small particles are found on the edges of the product.

The particles are part of the product design. The product is not defective.

---

## Other issue

When I try to change the PC resolution, a message "**The defined resolution is not supported.**" appears.

The message "**The defined resolution is not supported.**" appears if the input source resolution exceeds the maximum resolution of the display.

To resolve the issue, change the PC resolution to a resolution supported on the display.

There is no sound from the speakers in HDMI mode when a DVI-HDMI cable is connected.

DVI cables do not transmit sound data.

Make sure to connect the audio cable to the correct input jack to enable audio.

**HDMI Black Level** is not functioning properly on an HDMI device with YCbCr output.

This function is available only when a source device, such as a DVD player and STB, is connected to the product via an HDMI (RGB signal) cable.

There is no sound in HDMI mode.

Displayed picture colours may not look normal. Video or sound may not be available. This can occur if a source device that only supports an older version of the HDMI standard is connected to the product.

If these issues occur, connect an audio cable along with the HDMI cable.

Some PC graphics cards may not automatically recognise HDMI signals that do not include sound. In this case, manually select a sound input.

HDMI-CEC does not work.

This product does not support the HDMI-CEC feature.

To use several external devices compatible with the HDMI-CEC feature that are connected to the HDMI 1 and HDMI 2 ports on the product, turn off the HDMI-CEC features on all the external devices. External devices include Blu-ray and DVD players.

Operating an external device when its HDMI-CEC feature is enabled may automatically stop other external devices.

To change HDMI-CEC settings, refer to the device user guide or contact the device manufacturer for assistance.

---

## Q & A

### Question

How can I change the frequency?

---

– Refer to the user manual for your PC or graphics card for further instructions on adjustment.

### Answer

Set the frequency on your graphics card.

- Windows XP: Go to **Control Panel** → **Appearance and Themes** → **Display** → **Settings** → **Advanced** → **Monitor** and adjust the frequency in **Monitor Settings**.
- Windows ME/2000: Go to **Control Panel** → **Display** → **Settings** → **Advanced** → **Monitor** and adjust the frequency in **Monitor Settings**.
- Windows Vista: Go to **Control Panel** → **Appearance and Personalization** → **Personalize** → **Display Settings** → **Advanced Settings** → **Monitor** and adjust the frequency in **Monitor Settings**.
- Windows 7: Go to **Control Panel** → **Appearance and Personalization** → **Display** → **Adjust resolution** → **Advanced Settings** → **Monitor** and adjust the frequency in **Monitor Settings**.
- Windows 8: Go to **Settings** → **Control Panel** → **Appearance and Personalization** → **Display** → **Adjust resolution** → **Advanced Settings** → **Monitor** and adjust the frequency in **Monitor Settings**.
- Windows 10: Go to **Settings** → **System** → **Display** → **Advanced display settings** → **Display adapter properties** → **Monitor**, and adjust **Screen refresh rate** under **Monitor settings**.

How can I change the resolution?

- Windows XP: Go to **Control Panel** → **Appearance and Themes** → **Display** → **Settings** and adjust the resolution.
  - Windows ME/2000: Go to **Control Panel** → **Display** → **Settings** and adjust the resolution.
  - Windows Vista: Go to **Control Panel** → **Appearance and Personalization** → **Personalize** → **Display Settings** and adjust the resolution.
  - Windows 7: Go to **Control Panel** → **Appearance and Personalization** → **Display** → **Adjust Resolution** and adjust the resolution.
  - Windows 8: Go to **Settings** → **Control Panel** → **Appearance and Personalization** → **Display** → **Adjust Resolution** and adjust the resolution.
  - Windows 10: Go to **Settings** → **System** → **Display** → **Advanced display settings**, and adjust the resolution.
-

---

## Question

How do I set powersaving mode?

## Answer

- Windows XP: Set power-saving mode in **Control Panel** → **Appearance and Themes** → **Display** → **Screen Saver Settings** or BIOS SETUP on the PC.
  - Windows ME/2000: Set power-saving mode in **Control Panel** → **Display** → **Screen Saver Settings** or BIOS SETUP on the PC.
  - Windows Vista: Set power-saving mode in **Control Panel** → **Appearance and Personalization** → **Personalize** → **Screen Saver Settings** or BIOS SETUP on the PC.
  - Windows 7: Set power-saving mode in **Control Panel** → **Appearance and Personalization** → **Personalize** → **Screen Saver Settings** or BIOS SETUP on the PC.
  - Windows 8: Set power-saving mode in **Settings** → **Control Panel** → **Appearance and Personalization** → **Personalize** → **Screen Saver Settings** or BIOS SETUP on the PC.
  - Windows 10: Set power-saving mode in **Settings** → **Personalization** → **Lock screen** → **Screen timeout settings** → **Power & sleep** or BIOS SETUP on the PC.
-

# Chapter 12

## Specifications

– Size

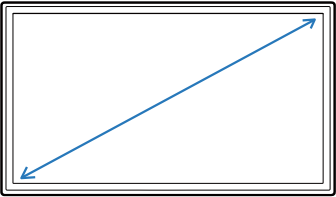

– Display area

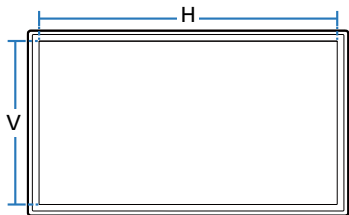

## General

Model Name

**OH75A**

Panel

Size

75 CLASS (74.5 inches / 189.2 cm)

Display area

1649.664 mm (H) x 927.936 mm (V)

Power Supply

AC100-240V~ 50/60Hz

Refer to the label at the back of the product as the standard voltage can vary in different countries.

Environmental considerations

Operating

Temperature : -30 °C to 50 °C (-22 °F to 122 °F)

\* For installing the enclosure, keep the internal temperature at 40 °C or below.

Humidity : 10% to 80%, non-condensing

Storage

Temperature : -20 °C to 50 °C (-4 °F to 122 °F)

Humidity : 5% to 95%, non-condensing

---

- Plug-and-Play

This monitor can be installed and used with any Plug-and-Play compatible systems. Two-way data exchange between the monitor and PC system optimises the monitor settings. Monitor installation takes place automatically. However, you can customise the installation settings if desired.

- Due to the nature of the manufacturing of this product, approximately 1 pixel per million (1ppm) may appear brighter or darker on the panel. This does not affect product performance.
- For detailed device specifications, visit the Samsung website.



---

## Preset Timing Modes

— This product can be set to only one resolution for each screen size to obtain the optimum picture quality due to the nature of the panel. Using a resolution other than the specified resolution may degrade the picture quality. To avoid this, it is recommended that you select the optimum resolution specified for your product.

### Model Name

**OH75A**

<b>Synchronization</b>	<b>Horizontal Frequency</b>	15 ~ 81 kHz (HDMI), 30 ~ 135 kHz (DP)
	<b>Vertical Frequency</b>	24 ~ 75 Hz (HDMI), 30 ~ 75 Hz (DP)
<b>Resolution</b>	<b>Optimum resolution</b>	3840 x 2160 @ 60 Hz
	<b>Maximum resolution</b>	

The screen will automatically be adjusted if a signal that belongs to the following standard signal modes is transmitted from your PC. If the signal transmitted from the PC does not belong to the standard signal modes, the screen may be blank with the power LED on. In such a case, change the settings according to the following table by referring to the graphics card user manual.

---

– **Horizontal Frequency**

The time required to scan a single line from the left to the right side of the screen is called a horizontal cycle. The reciprocal number of a horizontal cycle is called horizontal frequency. Horizontal frequency is measured in kHz.

– **Vertical Frequency**

The product displays a single image multiple times per second (like a fluorescent light) to display what the viewer sees. The rate of a single image being displayed repeatedly per second is called vertical frequency or refresh rate. Vertical frequency is measured in Hz.

Resolution	Horizontal Frequency (kHz)	Vertical Frequency (Hz)	Pixel Clock (MHz)	Sync Polarity (H/V)
IBM, 720 x 400	31.469	70.087	28.322	-/+
MAC, 640 x 480	35.000	66.667	30.240	-/-
MAC, 832 x 624	49.726	74.551	57.284	-/-
MAC, 1152 x 870	68.681	75.062	100.000	-/-
VESA, 640 x 480	31.469	59.940	25.175	-/-
VESA, 640 x 480	37.861	72.809	31.500	-/-
VESA, 640 x 480	37.500	75.000	31.500	-/-
VESA, 800 x 600	35.156	56.250	36.000	+/+
VESA, 800 x 600	37.879	60.317	40.00	+/+
VESA, 800 x 600	48.077	72.188	50.000	+/+
VESA, 800 x 600	46.875	75.000	49.500	+/+
VESA, 1024 x 768	48.363	60.004	65.000	-/-
VESA, 1024 x 768	56.476	70.069	75.000	-/-
VESA, 1024 x 768	60.023	75.029	78.750	+/+
VESA, 1152 x 864	67.500	75.000	108.000	+/+
VESA, 1280 x 720	45.000	60.000	74.250	+/+

Resolution	Horizontal Frequency (kHz)	Vertical Frequency (Hz)	Pixel Clock (MHz)	Sync Polarity (H/V)
VESA, 1280 x 800	49.702	59.810	83.500	-/+
VESA, 1280 x 1024	63.981	60.020	108.000	+/+
VESA, 1280 x 1024	79.976	75.025	135.000	+/+
VESA, 1366 x 768	47.712	59.790	85.500	+/+
VESA, 1440 x 900	55.935	59.887	106.500	-/+
VESA, 1600 x 900	60.000	60.000	108.000	+/+
VESA, 1680 x 1050	65.290	59.954	146.250	-/+
VESA, 1920 x 1080	67.500	60.000	148.500	+/+

# Chapter 13

## Appendix

### Responsibility for the Pay Service (Cost to Customers)

— When the service is requested, in spite of in warranty, we may charge you for a visit from a service technician in the following cases.

#### Not a product defect

Cleaning of the product, Adjustment, Explanation, Re-installation and etc.

- If a service technician gives instructions on how to use product or simply adjusts options without disassembling product.
- If a defect is caused by external environmental factors (Internet, Antenna, Wired Signal, etc.)
- If a product is reinstalled or devices are connected additionally after installing the purchased product for the first time.
- If a product is reinstalled to move to a different spot or to move to a different house.
- If customer requests instructions on how to use because of another company's product.
- If customer requests instructions on how to use the network or another company's programme.
- If customer requests software installation and setup for the product.
- If a service technician removes/cleans dusts or foreign materials inside of the product.
- If customer requests an installation additionally after purchasing a product through home-shopping or online.

### A Product damage caused by customer's fault

Product damage caused by customer's mishandling or wrong repair

If a product damage is caused by;

- External impact or drop.
- Use of supplies or separately sold product unspecified by Samsung.
- Repair from a person besides an engineer of outsourcing service company or partner of Samsung Electronics Co., Ltd.
- Remodeling or repairing the product by customer.
- Using it with incorrect voltage or non-authorized electrical connections.
- Not following the "cautions" in User Manual.

#### Others

- If product fails by natural disaster. (lightning, fire, earthquake, flood damage, etc)
  - If consumable components are all used up. (Battery, Toner, Fluorescent lights, Head, Vibrator, Lamp, Filter, Ribbon, etc.)
- If customer requests a service in case the product has no defect, service fee may be charged. So please read User Manual first.

## Prevention of Afterimage Burn-in

### What is afterimage burn-in?

Afterimage burn-in should not occur when the panel is operating normally. Normal operation refers to a continuously changing video pattern. If the panel displays a fixed pattern for an extended period of time a slight voltage difference may occur between the electrodes in pixels that control the liquid crystals.

Such a voltage difference between electrodes increases with time and makes the liquid crystals thinner. When this occurs, a previous image can remain on the screen when the pattern changes.

- ⊘ This information is a guide to prevent afterimage burn-in. Viewing a fixed screen for an extended period of time may cause afterimage burn-in. This problem is not included in warranty.

### Recommended prevention practices

Viewing a fixed screen for an extended period of time may cause afterimage burn-ins or smudges. If the product is not to be used for a long time, turn it off, or activate the Power Saving mode or Screen Saver with a moving image.

- Change the colours regularly.



- Avoid combinations of a text colour and background colour of contrasting brightness.
- Avoid using colours of contrasting brightness (black and white; grey and black).



---

## Licence



Dolby, Dolby Atmos, Dolby Audio and the double-D symbol are registered trademarks of Dolby Laboratories Licensing Corporation. Manufactured under license from Dolby Laboratories. Confidential unpublished works. Copyright © 2012-2021 Dolby Laboratories. All rights reserved.



The terms HDMI, HDMI High-Definition Multimedia Interface, HDMI trade dress and the HDMI Logos are trademarks or registered trademarks of HDMI Licensing Administrator, Inc.

---

### Open Source Licence Notice

In the case of using open source software, Open Source Licences are available on the product menu.

For information on the Open Source Licence Notice, contact Samsung Open Source (<http://opensource.samsung.com>)



THIS PRODUCT IS SOLD WITH A LIMITED LICENCE AND IS AUTHORISED TO BE USED ONLY IN CONNECTION WITH HEVC CONTENT THAT MEETS EACH OF THE THREE FOLLOWING QUALIFICATIONS: (1) HEVC CONTENT ONLY FOR PERSONAL USE; (2) HEVC CONTENT THAT IS NOT OFFERED FOR SALE; AND (3) HEVC CONTENT THAT IS CREATED BY THE OWNER OF THE PRODUCT.

THIS PRODUCT MAY NOT BE USED IN CONNECTION WITH HEVC ENCODED CONTENT CREATED BY A THIRD PARTY, WHICH THE USER HAS ORDERED OR PURCHASED FROM A THIRD PARTY, UNLESS THE USER IS SEPARATELY GRANTED RIGHTS TO USE THE PRODUCT WITH SUCH CONTENT BY A LICENSED SELLER OF THE CONTENT.

YOUR USE OF THIS PRODUCT IN CONNECTION WITH HEVC ENCODED CONTENT IS DEEMED ACCEPTANCE OF THE LIMITED AUTHORITY TO USE AS NOTED ABOVE.

---

---

# Terminology

**480i / 480p / 720p / 1080i /**

**1080p**\_\_\_\_\_ Each of the scanning rates above refers to the number of effective scanning lines that decides the screen resolution. The scanning rate may be indicated in i (interlaced) or p (progressive), depending on the scanning method.

- Scanning

Scanning refers to a process of sending pixels that form an image progressively. A larger number of pixels will deliver a clearer and more vivid picture.

- Progressive

In progressive scan mode, all lines of pixels are scanned one by one (progressively) on the screen.

- Interlaced

In interlaced scan mode, every other line of pixels is scanned from top to bottom first and then the remaining lines of pixels (that were not scanned) are scanned.

**Non-interlace Mode and Interlace Mode**\_\_\_\_\_

Non-interlace mode (progressive scan) displays a horizontal line from the top to the bottom of a screen progressively. Interlace mode displays the odd number lines first and the even number lines next. Non-interlace mode is mainly used in monitors as it produces screen clarity and interlace mode is mainly used in TVs.

**Dot Pitch**\_\_\_\_\_ The screen consist of red, green and blue dots. A shorter distance between the dots produces a higher resolution. Dot pitch refers to the distance between the shortest distance between dots of the same colour. Dot pitch is measured in millimetres.

**Vertical Frequency**\_\_\_\_\_ The product displays a single image many times per second (like a fluorescent light that flickers) to display an image for a viewer to see. The rate of a single image being displayed repeatedly per second is called vertical frequency or refresh rate. Vertical frequency is measured in Hz.

E.g. 60Hz refers to a single image being displayed 60 times in one second.

**Horizontal Frequency**\_\_\_\_\_ The time required to scan a single line from the left to the right side of the screen is called a horizontal cycle. The reciprocal number of a horizontal cycle is called horizontal frequency. Horizontal frequency is measured in kHz.

**Source**\_\_\_\_\_ Input source refers to a video source device connected to the product such as a camcorder or video or DVD player.

**Plug & Play**\_\_\_\_\_ Plug & Play is a function that allows the automatic exchange of information between a monitor and PC to produce an optimum display environment. The product uses VESA DDC (international standard) to execute Plug & Play.

**Resolution**\_\_\_\_\_ Resolution is the number of horizontal dots (pixels) and vertical dots (pixels) that form a screen. It represents the level of display detail. A higher resolution enables more data to be displayed on the screen and is useful to perform multiple tasks simultaneously.

E.g. A resolution of 1920 X 1080 consists of 1,920 horizontal pixels (horizontal resolution) and 1,080 vertical pixels (vertical resolution).

**DVD (Digital Versatile Disc)**\_\_\_\_\_ DVD refers to a CD-sized mass storage disk where you can save multimedia (audio, video or game) applications using MPEG-2 video compression technology.

**HDMI (High Definition Multimedia Interface)**\_\_\_\_\_ It is an interface that can be connected to a digital audio source as well as a high-definition video source by using a single cable without compression.

**Multiple Display Control (MDC)**\_\_\_\_\_ MDC (Multiple Display Control) is an application that allows multiple display devices to be controlled simultaneously using a PC. Communication between a PC and monitor takes place using RS232C (serial data transmission) and RJ45 (LAN) cables.